

ACTIE

BROCCHURE



**DH452068 VHM BOOR 6.8MM -
5xD - MET KOELKANALEN**

**NU VOOR
€ 31,20**
ex. btw



**GMF61918 VHM FREES 12MM
ONGELIJK VERDEELD MET NEK**

**NU VOOR
€ 54,50**
ex. btw

YOUNG
CUTTINGTOOLS

ALLES OP HET GEBIED VAN VERSPANING

Young cuttingtools is de grootste leverancier als het gaat om gereedschappen voor verspaning. U vraagt bij ons niet mis op het gebied van metaalbewerking en verspaning. Door middel van het geven van gerichte adviezen over toepassing en gebruik van de juiste gereedschappen zijn wij uw betrouwbare partner voor efficiënter produceren in de metaalbewerkingbranche.



BEZOEK AAN YG-1 IN PARIJS

Bij Young cuttingtools zijn we trots op het exclusieve dealerschap van YG-1. We hebben een kort bezoek gebracht aan het Europese distributiekantoor in Parijs (YG-1 EUROPE). Daar heeft de Koreaanse gigant voor 40 miljoen euro aan hoogwaardig verspaningsmateriaal in voorraad. Behalve heel erg leuk was het bezoek van ons (René van Ommen en Luuk Van Dongen) zeker ook nuttig want er komen weer een paar leuke acties aan!

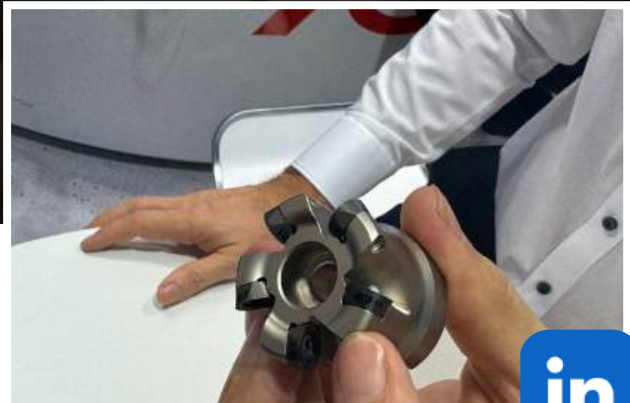

AMB-MESSE STUTTART

Het was goed toeven in de stad van Mercedes-Benz en Porsche. Niet dat René Van Ommen en Adri Pulles veel van die bolides hebben gezien, toch was het zeker nuttig en aangenaam op de hashtag AMB-messe in Stuttgart. Nieuwe contacten aangeboord en leuke gesprekken gevoerd met bestaande relaties. Met veel nieuwe kennis in het hoofd en nieuwe producten (o.a. Gerardi S.p.A., YG-1 en KORLOY) in de koffer waren het geslaagde dagen.

WIJ ZIJN ACTIEF OP LINKEDIN, VOLG ONS!

YOUNG
CUTTINGTOOLS

GEÏNTERESSEERD?

Neem gerust contact met ons op voor een vrijblijvend advies en informatie over wat Young cuttingtools voor uw bedrijf kan betekenen.

ONZE MERKEN

Wij zijn aanbieder van een totaalpakket aan verspanende gereedschappen en exclusief dealer van de topmerken YG-1, Avantec, Korloy en Ecoroll in de Nederlandse markt. Het Koreaanse YG-1 behoort tot de grootste producenten ter wereld van boren, tappen en frezen. Dus zoekt u een specifieke hoekfrees, vlakfrees of miniatuurfrees? Een titaniumfrees? Ook voor de juiste koelkanaalboor of volboor is Young cuttingtools het beste adres.

Het aanbod van Young cuttingtools wordt verder aangevuld met dealerschappen van Gerardi (opspangereedschappen), AMF (opspangereedschappen), Mitutoyo (meetgereedschappen), Nine9 (afbraam-, grafeer- en centergereedschappen) en Wemag totaalaanbieder.

WAAROM YOUNG CUTTINGTOOLS?

- ✓ Jarenlange ervaring
- ✓ Gericht advies
- ✓ Snelle levering
- ✓ Totaalpakket in verspaning



NIEUWS

Vakkennis is de kernkwaliteit van Young Cuttingtools. Zoals we onlangs hebben gemeld zijn we partner geworden van het topmerk Vargus. Intussen hebben we een speciale trainingsdag gehad om de gereedschappen goed te leren kennen, waarbij de focus lag op het maken van schroefdraden.

Meer info over de Vargus-producten vindt u op onze website.



Expertise
in efficiënter
produceren

BORENSET



€ 99,-

- Kruisaanslijping zelfcentrerend
- Geschikt voor rvs, gelegeerde en ongelegeerde staalsoorten
- Hoge standtijden

Premium HSS-E geslepen boren DIN338 met TIN-tip coating

Inhoud: 25 stuks 1-13 (0.5mm oplopend)

Bestelnummer: DLGP195SET2

BOOR / TAP SET



€ 82,50

- HSS Stoom ontladen
- Geschikt voor gelegeerde en ongelegeerde staalsoorten

Universeel boren/tappenset:

Inhoud: HSS-E Combo tappen M3, M4, M5, M6, M8, M10, M12

Inhoud: HSS-E Goldpoint boren Ø2.5, 3.3, 4.2, 5.0, 6.8, 8.5, 10.2

Bestelnummer doorlopend: TC814SET-DLGP

Bestelnummer blind: TC804SET-DLGP

STIFTFREZEN SET



€ 119,-

- Geschikt voor gelegeerde en ongelegeerde staalsoorten
- Schacht 6mm
- Hoge standtijden

Inhoud: Assortiment 10 stuks (6 t/m 12mm)

Bestelnummer: SETRB10

VERZINKBOREN SET



€ 99,-

- Geschikt voor gelegeerde en ongelegeerde staalsoorten
- Schacht 6mm
- Hoge standtijden

YG-1 HSS-Co8 Verzinkboreset 90° met TiAlN coating (8% Cobalt)

Inhoud: 6.3 | 8.3 | 10.4 | 12.4 | 16.5 | 20.5 | 25

• Bestelnummer: C1339S70

• Geschikt voor rvs, gelegeerde-, ongelegeerde staalsoorten

• Hoge standtijden

HSS-E TAPPENSET UNI



€ 65,-

- YG-1 speciale gepatenteerde geometrie
- Uitstekende prestaties in meerdere materialen (staal, rvs)
- Voor perfect gevormde schroefdraad
- Hoge standtijden

Inhoud: M3 | M4 | M5 | M6 | M8 | M10 | M12

Bestelnummer doorlopend: TC814SET7

Bestelnummer blind: TC804SET7

HSS-E TAPPENSET RVS



€ 75,-

- YG-1 RVS tappenserie
- YG-1 speciale gepatenteerde geometrie
- Uitstekende prestaties in RVS soorten
- Voor perfect gevormde schroefdraad
- Hoge standtijden

Inhoud: M3 | M4 | M5 | M6 | M8 | M10 | M12

Bestelnummer doorlopend: TB623SET7

Bestelnummer blind: TB914SET7

KING DRILL ACTIE



DE PERFECTE VOLBOOR VOORZIEN VAN WISSELPLATEN MET 4 SNIJKANTEN

Geoptimaliseerd ontwerp wisselplaatboor voor maximale boorefficiëntie.



PRODUCTINFORMATIE



Ø Boor (mm)	Grootte wisselplaat	Aantal wisselplaten		Lengte van de boor			
		Buiten 10x	Centrum 10x	2xD	3xD	4xD	5xD
12.0 – 13.5	4	SPMT040204-PD	XOMT040204-PD	€ 327,00	€ 327,00	€ 346,00	€ 440,00
14.0 – 16.0	5	SPMT050204-PD	XOMT050204-PD	€ 364,00	€ 364,00	€ 386,00	€ 492,00
16.5 – 19.5	6	SPMT060205-PD	XOMT060204-PD	€ 366,00	€ 366,00	€ 387,00	€ 493,00
20.0 – 23.5	7	SPMT07T208-PD	XOMT07T205-PD	€ 381,00	€ 381,00	€ 403,00	€ 517,00
24.0 – 29.5	9	SPMT090308-PD	XOMT090305-PD	€ 409,00	€ 409,00	€ 434,00	€ 557,00
30.0 – 35.5	11	SPMT11T308-PD	XOMT11T306-PD	€ 462,00	€ 462,00	€ 489,00	€ 629,00
36.0 – 42.5	13	SPMT130410-PD	XOMT130406-PD	€ 486,00	€ 486,00	€ 568,00	€ 662,00
43.0 – 50.5	15	SPMT15M510-PD	XOMT15M508-PD	€ 533,00	€ 533,00	€ 617,00	€ 733,00
51.0 - 60.5	18	SPMT180510-PD	XOMT180508-PD	€ 598,00	€ 598,00	€ 635,00	€ 819,00

Ø61-100 op aanvraag ** Coating van de wisselplaten zijn naar keuze.
*** Prijzen voor aluminium wisselplaat op aanvraag.

HIGHLY PRECISE AND EFFICIENT TOP SOLID INDEXABLE DRILL

TPDB PLUS DRILL



Special surface treatment
Improved durability of a holder

Advanced chip control
due to a chip breaker

High helix angle

High productivity
- Stable chip evacuation realizes stable machinability
- Decreases cycle time by applying improved cutting conditions

Improve in machining quality
- Good surface finish and regular size in the hole

Auto-centering system

Cutting edge with low cutting resistance
Low cutting load and excellent chip control

Screw on clamping system

SPANTANGHOUDERS ER

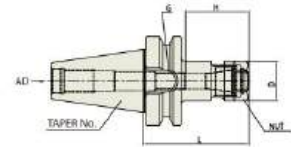
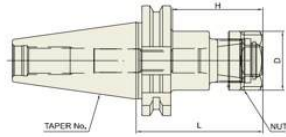

DIN 69871 -SK	Taper Accuracy AT3	G Value 6.3	RPM 15.000	Coolant System AD
-------------------------	------------------------------	-----------------------	----------------------	-----------------------------

JIS B6339 -BT	Taper Accuracy AT3	G Value 6.3	RPM 15.000	Coolant System AD
-------------------------	------------------------------	-----------------------	----------------------	-----------------------------

Artikelnummer	Model	Actieprijs
P2776417	SK40AD - ER16 - 70	€ 30,00
P2527018	SK40AD - ER16 - 100	€ 35,00
P2776418	SK40AD - ER20 - 70	€ 30,00
P2527019	SK40AD - ER20 - 100	€ 35,00
P2776419	SK40AD - ER25 - 70	€ 30,00
P2776429	SK40AD - ER25 - 100	€ 35,00
P2776420	SK40AD - ER32 - 70	€ 30,00
P2776430	SK40AD - ER32 - 100	€ 35,00
P2527011	SK40AD - ER40 - 80	€ 35,00

Artikelnummer	Model	Actieprijs
P2772101	BT40AD - ER16 - 75	€ 30,00
P2772118	BT40AD - ER16 - 100	€ 35,00
P2772102	BT40AD - ER20 - 75	€ 30,00
P2772120	BT40AD - ER20 - 100	€ 35,00
P2772103	BT40AD - ER25 - 75	€ 30,00
P2772122	BT40AD - ER25 - 100	€ 35,00
P2772104	BT40AD - ER32 - 60	€ 30,00
P2772125	BT40AD - ER32 - 100	€ 35,00
P2772127	BT40AD - ER40 - 80	€ 35,00



ER 8 P2506301		
STANDAARD SET	208000	€ 89,-
Ø 1.0 - 5.0mm		
9pcs		
CASSETTE ZWT 8	108110	

ER 11 P2506302		
STANDAARD SET	211000	€ 115,-
Ø 1.0 - 7.0mm		
13pcs		
CASSETTE ZWT 11	011110	

ER 16 P2506303		
STANDAARD SET	216000	€ 89,-
Ø 1.0 - 10.0mm		
10pcs		
CASSETTE ZWT 16	016110	

ER 20 P2506304		
STANDAARD SET	220000	€ 105,-
Ø 2.0 - 13.0mm		
12pcs		
CASSETTE ZWT 20	020110	

ER 25 P2506305		
STANDAARD SET	225000	€ 133,-
Ø 2.0 - 16.0mm		
15pcs		
CASSETTE ZWT 25	025110	

ER 32 P2506306		
STANDAARD SET	232000	€ 166,-
Ø 3.0 - 20.0mm		
18pcs		
CASSETTE ZWT 32	032110	

ER 40 P2506307		
STANDAARD SET	240000	€ 230,-
Ø 4.0 - 26.0mm		
23pcs		
CASSETTE ZWT 40	040110	

ER 50 P2506308		
STANDAARD SET	250000	€ 280,-
Ø 12.0 - 34.0mm		
12pcs		
CASSETTE ZWT 50	050110	

ER SPANTANGSLEUTELS

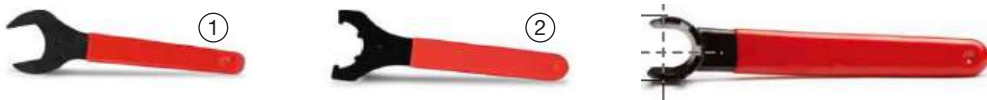

Artikelnummer	Model	Actieprijs
P2772601	SLEUTEL ER11 (fig.1)	€ 7,50
P2772602	SLEUTEL ER16 (fig.1)	€ 7,50
P2772603	SLEUTEL ER20 (fig.1)	€ 7,50
P2772604	SLEUTEL ER25 (fig.2)	€ 7,50
P2772605	SLEUTEL ER32 (fig.2)	€ 7,50
P2772606	SLEUTEL ER40 (fig.2)	€ 7,50

Artikelnummer	Model	Actieprijs
P2772612	SLEUTEL ER50 (fig.2)	€ 8,50
P2772608	SLEUTEL MINI ER8	€ 11,00
P2772609	SLEUTEL MINI ER11	€ 11,00
P2772610	SLEUTEL MINI ER16	€ 11,00
P2772611	SLEUTEL MINI ER20	€ 13,00
P2772607	SLEUTEL MINI ER25	€ 13,00

OPSTEEKHOUDERS



DIN 69871 -SK	Taper Accuracy AT3	G Value 6.3	RPM 15.000	Coolant System AD
---------------	--------------------	-------------	------------	-------------------

Artikelnummer	Model	Actieprijs
P2778904	SK40AD - SMA16-60	€ 35,00
P2778905	SK40AD - SMA22-60	€ 35,00
P2778906	SK40AD - SMA27-60	€ 37,00
P2778907	SK40AD - SMA32-60	€ 39,00
P2778908	SK40AD - SMA40-60	€ 49,00



JIS B6339 -BT	Taper Accuracy AT3	G Value 6.3	RPM 15.000	Coolant System AD
---------------	--------------------	-------------	------------	-------------------

Artikelnummer	Model	Actieprijs
P2778804	BT40AD - SMA16-60	€ 35,00
P2778805	BT40AD - SMA22-60	€ 35,00
P2778806	BT40AD - SMA27-60	€ 37,00
P2778807	BT40AD - SMA32-60	€ 39,00
P2778808	BT40AD - SMA40-60	€ 49,00

WELDONHOUDERS

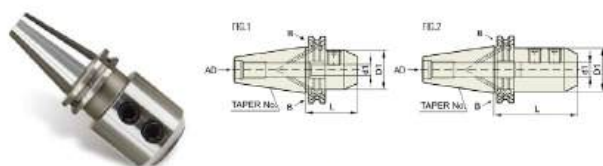

DIN 69871 -SK	Taper Accuracy AT3	G Value 6.3	RPM 15.000	Coolant System AD
---------------	--------------------	-------------	------------	-------------------

Artikelnummer	Model	Actieprijs
P2521009	SK40AD - EMH6-50	€ 25,00
P2521010	SK40AD - EMH8-50	€ 25,00
P2521011	SK40AD - EMH10-50	€ 25,00
P2521012	SK40AD - EMH12-50	€ 25,00
P2521013	SK40AD - EMH16-63	€ 25,00
P2521014	SK40AD - EMH20-63	€ 25,00
P2521015	SK40AD - EMH25-100	€ 31,00
P2521016	SK40AD - EMH12-100	€ 33,00

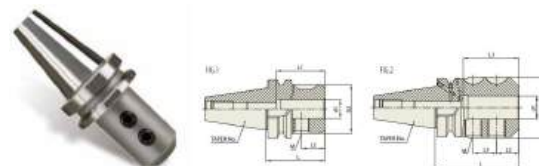

JIS B6339 -BT	Taper Accuracy AT3	G Value 6.3	RPM 15.000	Coolant System AD
---------------	--------------------	-------------	------------	-------------------

Artikelnummer	Model	Actieprijs
P2773061	BT40AD - EMH6-50	€ 25,00
P2773062	BT40AD - EMH8-50	€ 25,00
P2773063	BT40AD - EMH10-63	€ 25,00
P2773064	BT40AD - EMH12-63	€ 25,00
P2773066	BT40AD - EMH16-63	€ 25,00
P2773068	BT40AD - EMH20-63	€ 25,00
P2773069	BT40AD - EMH25-90	€ 31,00
P2773070	BT40AD - EMH32-100	€ 33,00

AMF GRIPPER

De gripper bereikt een volledig automatische werkstukwissel tijdens het bewerkingsproces op een machinegereedschap. Heeft eenvoudig verwisselbare gripperinzetstukken voor het hanteren van verschillende werkstukgeometrieën.

- Hydraulisch of pneumatisch
- Met én zonder compensatie-EE
- Gripperuitbreiding 80 mm of 10



AMF-MARKER LARGE



PRODUCTINFORMATIE



Perfect voor het labelen van verschillende materialen, zoals plastic, staal en roestvrij staal. Directe naaldwissel door de markeernaald eruit te trekken



YG-1 VLAKFREES PNMU12

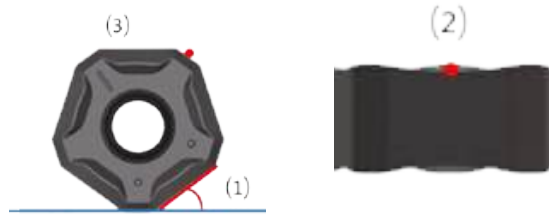

PRODUCTINFORMATIE



De PNMU heeft 10 snijkanten met een inloophoek van 36 graden, wat zorgt voor een hogere productiviteit en stabiele snijprestaties!

1. INLOOPHOEK 36°

- Verhoogt de voedingssnelheid
- Kleinere gemiddelde spaandikte

2. GEBOGEN SNIJKANT MET WIPER

- Verbeter de snijkraft en de oppervlakterutheid

3. SNIJKANTEN PER WISSELPLAAT

- Kostenbesparend voor de klant

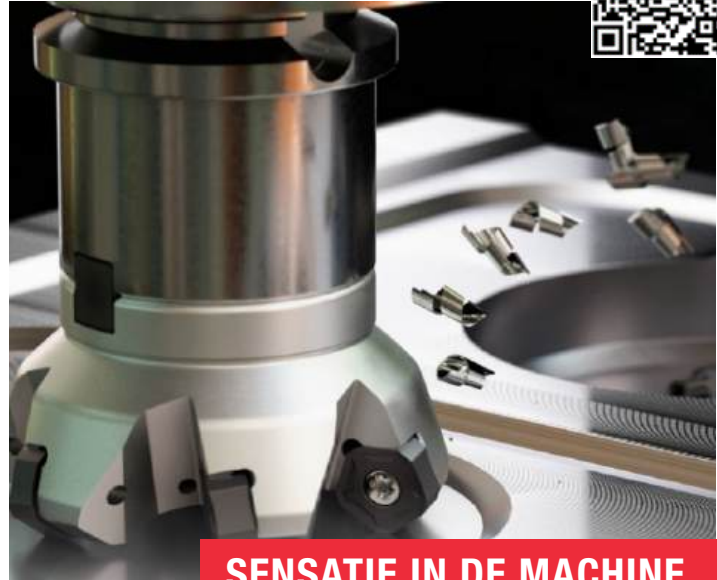

SENSATIE IN DE MACHINE

YG-1 TPKT HOEFREES 90°

- Geoptimaliseerde geometrie
- Minimale braamvorming



PRODUCTINFORMATIE



POSITIEVE WISSELPLAAT



90° Hoekfrees

Grotere kern zorgt voor betere stijfheid

Optimale plaatsing van de wisselplaten zorgt voor een hoge productiviteit



NIEUW

NIEUWE CVD-DRAAIWISSELPLAAT YG2025 VOOR HOGE SNIJSNELHEID IN RVS SOORTEN



- Vernieuwd hardmetaalkwaliteit en nieuwe coating!
- Uitzonderlijke prestaties in RVS bij hoge snijsnelheid
- Zeer geschikt voor massaproductie vanwege stabiele en voorspelbare standtijd
- Meerdere verschillende spaanbrekers
- Beste keuze voor zowel continue als onderbroken sneden
- Minimaliseren van snijkantsopbouw door nieuwe nabehandeling van de wisselplaat

NIEUW

NIEUWE CVD-DRAAIWISSELPLAAT YG3115 VOOR HOGE SNIJSNELHEID IN STAAL SOORTEN



- Uitzonderlijke prestaties in staal bij hoge snijsnelheid
- Uitstekend oppervlak
- Zeer geschikt voor massaproductie vanwege stabiele en voorspelbare standtijd
- Beste keuze voor zowel continue als onderbroken sneden
- Meerdere verschillende spaanbrekers
- Minimaliseren van snijkantsopbouw door nieuwe nabehandeling van de wisselplaat

YG-1 DRAAI WISSELPLATEN

SNIJGEGEVENS



Wisselplaten	R	ISO Code	Mutli YG213	Staal YG3115	RVS YG2025	HRSA YG401	Gietijzer YG10	Aluminium YG10	Actie prijs	
CNMG		0,8	CNMG090308	-	22002589	-	-	-	€ 4,48	
		1,2	CNMG090312	-	22002590	-	-	-	€ 4,48	
		0,4	CNMG120404	22000548	22002219	22002465	22002286	22000895	-	€ 5,96
		0,8	CNMG120408	22000495	22002178	22002468	22002287	22001483	-	€ 5,96
		1,2	CNMG120412	22000550	22002199	22002469	22002288	22000873	-	€ 5,96
		1,6	CNMG120416	-	22002213	-	22001912	-	-	€ 5,96
DCGT		0,2	DCGT070201	-	-	-	22002068	-	€ 6,11	
		0,4	DCGT070202	-	-	-	22002069	-	22001399	€ 6,11
		0,8	DCGT070204	-	-	-	22002070	-	22001400	€ 6,11
		0,1	DCGT11T301	-	-	-	22002075	-	-	€ 7,22
		0,2	DCGT11T302	-	-	-	22001474	-	22000341	€ 7,22
		0,4	DCGT11T304	-	-	-	22001463	-	22000083	€ 7,22
		0,8	DCGT11T308	-	-	-	22002076	-	22000084	€ 7,22
DCMT		0,4	DCMT070204	22002000	22002391	22002516	-	22001849	-	€ 4,66
		0,8	DCMT070208	-	22002386	22002817	-	22001850	-	€ 4,66
		0,4	DCMT11T304	22001991	22002209	22002517	22002041	22001831	-	€ 5,52
		0,8	DCMT11T308	22001985	22002215	22002518	22002042	22001832	-	€ 5,52
DNMG		0,4	DNMG110404	-	22002606	22002839	-	-	-	€ 5,52
		0,8	DNMG110408	-	22002607	22002840	-	-	-	€ 5,52
		0,4	DNMG150404	22000552	-	22002466	-	22001618	-	€ 7,22
		0,8	DNMG150408	22000514	22002368	22002470	22001300	-	-	€ 7,22
		1,2	DNMG150412	22000562	-	22002483	22001303	22001514	-	€ 7,22
		0,4	DNMG150604	22000554	22002375	22002467	-	22001619	-	€ 7,92
		0,8	DNMG150608	22000516	22002212	22002471	22001301	22001609	-	€ 7,92
		1,2	DNMG150612	22000564	22002356	22002484	22001302	22001511	-	€ 7,92
KNUX		0,5	KNUX160405L	-	22002621	-	-	-	-	€ 7,22
		0,5	KNUX160405R	-	22002408	-	-	-	-	€ 7,22
		1	KNUX160410L	-	22002622	-	-	-	-	€ 7,22
		1	KNUX160410R	-	22002623	-	-	-	-	€ 7,22
RCMT		3	RCMT0602M0	-	22002624	-	-	-	-	€ 4,26
		4	RCMT0803M0	-	22002625	-	-	-	-	€ 4,66
		5	RCMT10T3M0	-	22002626	-	-	-	-	€ 5,11
		6	RCMT1204M0	-	22002627	-	-	-	-	€ 5,73
SCMT		0,4	SCMT09T304	-	22002414	22002819	-	-	-	€ 5,52
		0,8	SCMT09T308	-	22002383	22002820	-	-	-	€ 5,52
		0,8	SCMT120408	22001974	22002393	22002519	22001976	-	-	€ 9,07

YG-1 DRAAI WISSELPLATEN

SNIJGEGEVENS



Wisselplaten	R	ISO Code	Mutli YG213	Staal YG3115	RVS YG2025	HRSA YG401	Gietijzer YG10	Aluminium YG10	Actie prijs
SNMG		0,4	SNMG120404	-	-	22002485	-	-	€ 5,96
		0,8	SNMG120408	22000556	22002361	22002475	22001305	-	€ 5,96
		1,2	SNMG120412	22000566	22002411	22002486	22001304	-	€ 5,96
		1,6	SNMG120416	-	22002638	-	-	-	€ 5,96
TCGT		0,4	TCGT110204	-	-	-	-	22001333	€ 5,11
		0,2	TCGT16T302	-	-	-	-	22000343	€ 6,73
		0,4	TCGT16T304	-	-	-	-	22000085	€ 6,73
		0,8	TCGT16T308	-	-	-	-	22000086	€ 6,73
TCMT		0,4	TCMT110204	-	22002642	22002824	-	22001839	€ 4,66
		0,8	TCMT110208	-	22002362	22002825	-	22001851	€ 4,66
		0,4	TCMT16T304	22001994	22002379	22002520	22002043	22001840	€ 6,18
		0,8	TCMT16T308	22001953	22002175	22002521	22001955	22001841	€ 6,18
TNMG		0,4	TNMG160404	22000568	22002171	22002472	-	22001620	€ 5,52
		0,8	TNMG160408	22000570	22002182	22002473	-	22001140	€ 5,52
		1,2	TNMG160412	22000603	22002200	22002474	22001288	22001142	€ 5,52
		0,8	TNMG220408	-	22002394	-	-	22001641	€ 6,81
		1,2	TNMG220412	-	22002694	-	-	22001642	€ 6,81
		1,6	TNMG220416	-	-	-	-	22001647	€ 6,81
VBMT		0,4	VBMT160404	22001997	22002181	22002522	-	-	€ 7,66
		0,8	VBMT160408	22001988	22002211	22002523	-	-	€ 7,66
VCGT		0,1	VCGT110301	-	-	-	22002077	22001041	€ 7,15
		0,2	VCGT110302	-	-	-	22001481	22001042	€ 7,15
		0,4	VCGT110304	-	-	-	22002078	22001518	€ 7,15
		0,8	VCGT110308	-	-	-	22002079	-	€ 8,43
		0,2	VCGT160402	-	-	-	-	22000417	€ 8,33
		0,4	VCGT160404	-	-	-	-	22000087	€ 8,33
		0,8	VCGT160408	-	-	-	-	22000419	€ 8,33
VCMT		0,4	VCMT110304	-	-	22002829	22002035	-	€ 6,48
		0,4	VCMT160404	-	22002385	22002830	-	-	€ 7,66
		0,8	VCMT160408	-	22002699	22002831	-	22001853	€ 7,66
WNMG		0,4	WNMG060404	-	22002415	22002487	-	-	€ 5,11
		0,8	WNMG060408	-	22002428	22002476	-	22001649	€ 5,11
		1,2	WNMG060412	-	-	22002477	22001439	22001317	€ 5,11
		0,4	WNMG080404	22000572	22002389	22002488	-	22001580	€ 5,96
		0,8	WNMG080408	22000498	22002173	22002478	22001311	22000908	€ 5,96
		1,2	WNMG080412	22000615	22002708	22002479	22001312	22000910	€ 5,96

NC SPOT DRILL

Één gereedschap voor meerdere toepassingen

- Graveren, centreren, afkanten en v-groeven
- Hoge standtijd
- Elke wisselplaat heeft 2 of 4 snijkanten
- 45° / 60° / 82° / 90° / 100° / 120° / 142° Hoek voor verschillende toepassingen



ACTIE
€ 209,-



PRODUCTINFORMATIE

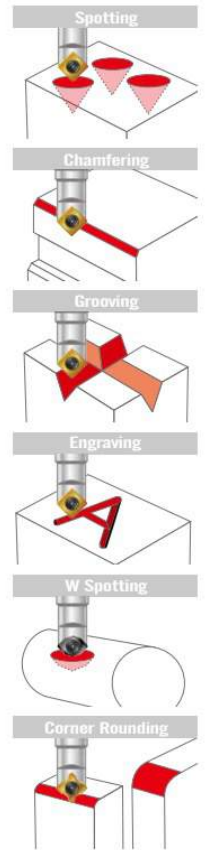

Artikelnummer: 604204-4401

DRAAIMOMENT SCHROEVENDRAAIERSET TORX, 25MM + 50MM BITS SLOKY

ACTIE
€ 159,-

Artikelnummer	Inhoud					
	Handgreep	Adapter				Bit
		Grootte	Nm	Kgfm	In-lb	25mm + 50mm
0-TPK01-TGTX-12K	0-TPK-H02-R	TX06	0.6	6.1	5.3	ACTIE € 159,-
		TX07	0.9	9.2	8.0	
		TX08	1.2	12.0	10.6	
	0-TPK-H01-R	TX09	1.4	14.0	12.4	
		TX10	2.0	20.4	17.7	
		TX15	3.0	30.6	26.6	



EXTRA LONG VISES

Vises with the extra large base dimension, much longer than std vises - Ideal for vertical machining centres

ART. 21

(Single Clamping)



Std Equipment: 1 workshop, 2 positioning key-nuts for 16 mm slot, 2 inserts Art. 291, 1 box wrench, 1 "T" wrench

+ 6 Holding clamps Art. 298

XL modular vise with standard dotation

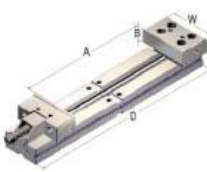

Type	Max opening A	Jaw width W	Jaw Height B	Base Length D	Kg	Code	LIST PRICE €	SPECIAL PRICE €
2	320	125 mm	40	520	17	2.21.23200	1.147	800
3	380	150 mm	50	580	32	2.21.33600	1.425	1.000
	490			60	2.21.34600	1.576	1.150	
4	500	175 mm	60	766	52	2.21.45000	1.828	1.350
				866	56	2.21.46000	1.990	1.450
				966	61	2.21.47000	2.159	1.550

REDUCTION UP TO 20%



PARALLEL MAGNETIC PLATES

Wide range of heights available on page 4.27 - General price list w17

REDUCTION UP TO 40%

FOR VISES STANDARD & STANDARDFLEX ART.1 = ART.1A



Thickness: 2,8mm

ART. 414

Also Available Universal Parallel magnetic plates

ART. 310

Type	LIST PRICE EACH €
1	73
2	93
3	116
4	136
5	155
6	176

Price each in case of set purchase

PRICE EACH €	6 pairs of parallel bars (Art.313-313R) KIT PRICE €
50	300
65	390
75	450
90	540
100	600
120	720

ART. 311

PRICE EACH €	10 pairs of parallel bars (Art.313-313R) KIT PRICE €
-	-
-	-
70	700
80	800
90	900
100	1.000



TOMBSTONES

Solid cast iron cast with double stress relieving heat treatment - Ideal for orizontal machining centres made in italy

STANDARD JAPANESE

BASE/HEIGHT REDUCTION: € 220

ART. S3 B

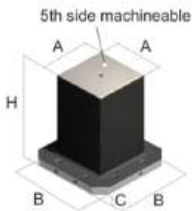

Cod.	A	B	C	D	H	Kg	LIST PRICE €	SPECIAL PRICE €
8.53.B00080	260	400	45	-	550	197	1.853	1.550
8.53.B00081	260	400	45	-	660	228	2.139	1.690
8.53.B00100	260	500	45	-	650	255	2.417	2.000
8.53.B00105	260	500	45	-	750	284	2.605	2.000
8.53.B00115	310	500	45	-	900	383	3.551	2.700
8.53.B00171	360	500	45	-	700	356	3.328	2.500
8.53.B00180	360	630	45	-	820	452	4.217	3.200
8.53.B00211	510	630	45	-	860	61	5.858	3.850

* Only for pallets with "T" slots

ART. S3 B2 PLUS

Cod.	Kg	LIST PRICE €	SPECIAL PRICE €
8.53.B20080	182	2.361	1.950
8.53.B20081	204	2.680	2.050
8.53.B20100	238	3.027	2.400
8.53.B20105	254	3.138	2.500
8.53.B20115	354	4.311	3.300
8.53.B20171	326	4.041	3.050
8.53.B20180	427	5.277	4.200
8.53.B20211	593	7.113	4.350

A One integral G30 cast iron casting milled with double stressrelieving heat treatment. Wall thickness 43-45mm. Tolerance +12 / -5 mm

B Rough casting with machined and hand scraped base face for direct clamping on Japanese standard pallet. Base with 4 precision holes Ø20F7 and bottom threads M16 with precise pitch dimensions for the use of our Zero Point or to be interface with other pallets or head plates. Ready for installation and to be machined for reset with machine axis. Tolerance +12 / -5 mm

C Cube completely finished with wall thickness roughly 38-40mm. Tolerance ± 0,02 mm

B2 PLUS 1mm overstock on each side. Ready for installation and to be machined for reset with machine axis.

E Integral cube with calibrated holes and solid threads. Tolerance ± 0,02 mm

F Integral cube with hardened bushing 100 Cr6 and stainless steel helicoils. Tolerance ± 0,02mm

ART. S5 B

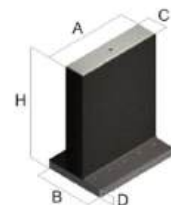

Cod.	A	B	C	D	H	Kg	LIST PRICE €	SPECIAL PRICE €
8.55.B00052	410	400	160	50	660	244	2.345	1.800
8.55.B00053	510	500	160	50	700	331	3.131	2.400
8.55.B00054	510	500	210	55	600	316	3.042	2.300
8.55.B00170	640	450	160	55	820	460	4.347	3.200
8.55.B00172	640	630	210	55	850	545	5.178	3.540
8.55.B00190	810	450	160	65	800	604	5.805	4.040

ART. S5 B2 PLUS

Cod.	Kg	LIST PRICE €	SPECIAL PRICE €
8.55.B20052	206	2.846	2.150
8.55.B20053	303	3.801	2.900
8.55.B20054	301	3.693	2.800
8.55.B20170	433	5.278	4.000
8.55.B20172	520	6.288	4.500
8.55.B20190	782	7.048	4.900

ART. S7 B

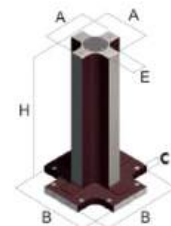

Cod.	A	B	C	D	H	Kg	LIST PRICE €	SPECIAL PRICE €
8.57.B00100	210	500	50	80	750	157	1.715	1.550
8.57.B00110	280	500	50	80	850	235	2.126	1.950
8.57.B00120	240	500	50	110	850	218	2.049	1.850
8.57.B00130	310	500	50	150	850	269	2.466	2.050
8.57.B00140	310	630	50	150	950	327	2.790	2.450

ART. S7 B2 PLUS

Cod.	Kg	LIST PRICE €	SPECIAL PRICE €
8.57.B20100	155	2.075	1.850
8.57.B20110	241	2.608	2.300
8.57.B20120	216	2.556	2.250
8.57.B20130	232	2.974	2.550
8.57.B20140	325	3.293	2.650

GERARDI MODULAIRE PRECISIE MACHINEKLEM

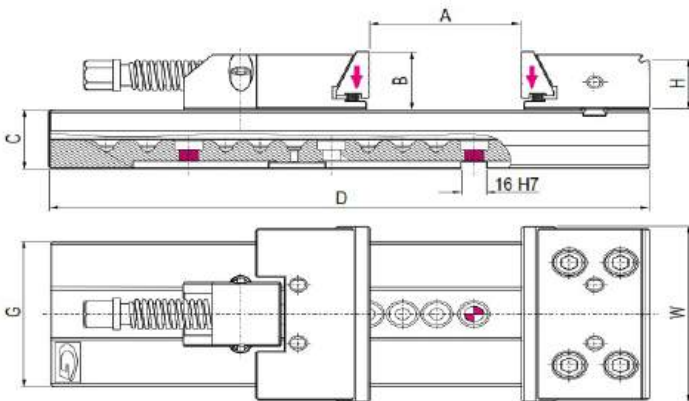

Afmetingen	Type 3 30 kN	Normaal	Actieprijs
A max.	300	€ 957,-	ACTIE € 698,-
W	150		
B	50		
C	50		
D	520		
G	125		
kg	29		
Artikel	3.03.3000		

* PRIJS IS INCLUSIEF:

- 1 stuk werkstukaanslag Art. 370
- 4 stuks opspanblokken Art. 298
- 1 set positioneerblokjes Art. 297
- 1 spansleutel Art. 375
- 1 zeskant stelsleutel Art. 376

COMPACT GRIP VISES

Self centering vises with reversible jaws - Ideal for 5 axis machining centres

ART. 650

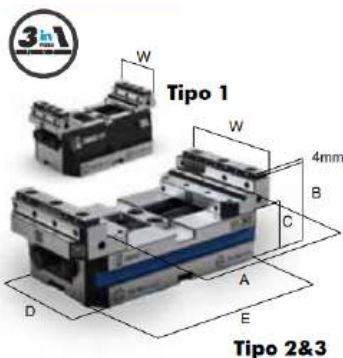

TYPE	jaw width	Max opening	Vise height	Base height	Base width	Base width	Kg	Code	LIST PRICE	ACTIE PRIJS
	W	A	B	C	D	E				
1 12kN	50	54	65	45	79,9	80	1,9	7.65.01080	€ 777,00	€ 649,00
		94				2,7	7.65.01120	€ 897,00	€ 749,00	
		134				3,4	7.65.01160	€ 1015,00	€ 849,00	
2 22kN	88	96	65	38	89,9	120	3,6	7.65.02120	€ 955,00	€ 749,00
		136				4,4	7.65.02160	€ 1075,00	€ 849,00	
		176				5,2	7.65.02200	€ 1194,00	€ 949,00	
		216				5,8	7.65.02240	€ 1314,00	€ 1049,00	
3 32kN	123	133	89	57	124,9	160	9,1	7.65.03160	€ 1552,00	€ 1199,00
		183				10,9	7.65.03210	€ 1790,00	€ 1299,00	
		233				12,8	7.65.03260	€ 2029,00	€ 1399,00	
		283				14,8	7.65.03310	€ 2387,00	€ 1649,00	
		333				17	7.65.03360	€ 2625,00	€ 1849,00	



Standard equipment: 1 Box wrench, 1 calibrated centering, 2 position key-nuts and self-centering key-nuts, 2 top jaw inserts Art. 650T G11 pitch 11 mm

+ Magnetic Workshop Art. 370EM

VHM HOEK-/ AFBRAAMFREZEM

4-SNIJDERS, TIALN GECOAT 90° OF 60°

YOUNG
CUTTINGTOOLS

Vlakke punt met cilindrische opname



Artikelnummer	Ø (mm)	Dc (mm)	Lt (mm)	Hoek	Z	fz (mm/z)	Nettoprijs	Actieset
YCT1009006	6	1,2	57	90°	4	0,04-0,06	€ 14,-	€102,50 € 90,-
YCT1009008	8	1,6	63	90°	4	0,06-0,08	€ 19,50	
YCT1009010	10	2,0	72	90°	4	0,08-0,12	€ 28,-	
YCT1009012	12	2,4	83	90°	4	0,10-0,14	€ 41,-	

Artikelnummer	Ø (mm)	Dc (mm)	Lt (mm)	Hoek	Z	fz (mm/z)	Nettoprijs	Actieset
YCT1006006	6	1,2	57	60°	4	0,03-0,04	€ 14,-	€102,50 € 90,-
YCT1006008	8	1,6	63	60°	4	0,04-0,06	€ 19,50	
YCT1006010	10	2,0	72	60°	4	0,06-0,08	€ 28,-	
YCT1006012	12	2,4	83	60°	4	0,09-0,11	€ 41,-	

Scherp punt met cilindrische opname



Artikelnummer	Ø (mm)	Lt (mm)	Hoek	Z	fz (mm/z)	Nettoprijs	Actieset
YCT1019006	6	57	90°	4	0,04-0,06	€ 15,-	€108,50 € 95,-
YCT1019008	8	63	90°	4	0,06-0,08	€ 21,-	
YCT1019010	10	72	90°	4	0,08-0,12	€ 29,-	
YCT1019012	12	83	90°	4	0,10-0,14	€ 43,-	

Artikelnummer	Ø (mm)	Lt (mm)	Hoek	Z	fz (mm/z)	Nettoprijs	Actieset
YCT1016006	6	57	60°	4	0,03-0,04	€ 15,-	€108,50 € 95,-
YCT1016008	8	63	60°	4	0,04-0,06	€ 21,-	
YCT1016010	10	72	60°	4	0,06-0,08	€ 29,-	
YCT1016012	12	83	60°	4	0,09-0,11	€ 43,-	

Materiaalgroepen & snijsnelheid

	Materiaal	Treksterkte	Hardheid	VC optimaal M/Min
P	Standaard koolstofstaal	<600	<230	180
	Gelegeerd staal	<1200	<350	100
	Hooggelegeerd staal & gereedschapsstaal	<1400	<380	80
M	Austenitisch & Ferritisch RVS	<680	<220	90
	Martensitisch RVS	<820	<240	80
K	Grijs gietijzer		<280	140
	Nodulair gietijzer		<320	100
S	Legeringen op hoge temp. (Fe, Ni, Co)	<3300	<350	50
	Titaniumlegeringen Alpha & Beta	<2100	<400	70
H	Gehard staal		<54 HRC	60

YG-1 VHM BOOR 5XD MET INTERNE KOELING INOX

PRODUCTINFORMATIE

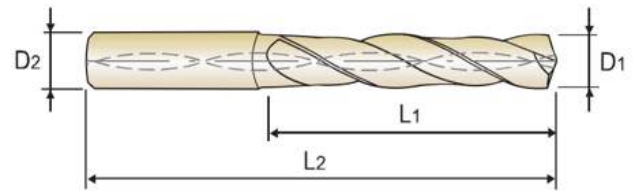

Art. nr	D1	D2	L1	L2	Actie prijs
DH452010	1.0	3	8	55	€ 25,50
DH452011	1.1	3	12	55	€ 25,50
DH452012	1.2	3	12	55	€ 25,50
DH452013	1.3	3	12	55	€ 25,50
DH452014	1.4	3	12	55	€ 25,50
DH452015	1.5	3	16	55	€ 25,50
DH452016	1.6	3	16	55	€ 25,50
DH452017	1.7	3	16	55	€ 25,50
DH452018	1.8	3	16	55	€ 25,50
DH452019	1.9	3	16	55	€ 25,50
DH452020	2	4	21	57	€ 25,50
DH452021	2.1	4	21	57	€ 25,50
DH452022	2.2	4	21	57	€ 25,50
DH452023	2.3	4	21	57	€ 25,50
DH452024	2.4	4	21	57	€ 25,50
DH452025	2.5	4	21	57	€ 25,50
DH452026	2.6	4	21	57	€ 25,50
DH452027	2.7	4	21	57	€ 25,50
DH452028	2.8	4	21	57	€ 25,50
DH452029	2.9	4	21	57	€ 25,50
DH452030	3	6	28	66	€ 28,25
DH452031	3.1	6	28	66	€ 28,25
DH452032	3.2	6	28	66	€ 28,25
DH452033	3.3	6	28	66	€ 28,25
DH452034	3.4	6	28	66	€ 28,25
DH452035	3.5	6	28	66	€ 28,25
DH452036	3.6	6	28	66	€ 28,25
DH452037	3.7	6	28	66	€ 28,25
DH452038	3.8	6	36	74	€ 28,25
DH452039	3.9	6	36	74	€ 28,25
DH452040	4	6	36	74	€ 28,25
DH452041	4.1	6	36	74	€ 28,25
DH452042	4.2	6	36	74	€ 28,25
DH452043	4.3	6	36	74	€ 28,25
DH452044	4.4	6	36	74	€ 28,25
DH452045	4.5	6	36	74	€ 28,25
DH452046	4.6	6	36	74	€ 28,25

Art. nr	D1	D2	L1	L2	Actie prijs
DH452047	4.7	6	36	74	€ 28,25
DH452048	4.8	6	44	82	€ 28,25
DH452049	4.9	6	44	82	€ 28,25
DH452050	5	6	44	82	€ 28,25
DH452051	5.1	6	44	82	€ 28,25
DH452052	5.2	6	44	82	€ 28,25
DH452053	5.3	6	44	82	€ 28,25
DH452054	5.4	6	44	82	€ 28,25
DH452055	5.5	6	44	82	€ 28,25
DH452056	5.6	6	44	82	€ 28,25
DH452057	5.7	6	44	82	€ 28,25
DH452058	5.8	6	44	82	€ 28,25
DH452059	5.9	6	44	82	€ 28,25
DH452060	6	6	44	82	€ 28,25
DH452061	6.1	8	53	91	€ 31,20
DH452062	6.2	8	53	91	€ 31,20
DH452063	6.3	8	53	91	€ 31,20
DH452064	6.4	8	53	91	€ 31,20
DH452065	6.5	8	53	91	€ 31,20
DH452066	6.6	8	53	91	€ 31,20
DH452067	6.7	8	53	91	€ 31,20
DH452068	6.8	8	53	91	€ 31,20
DH452069	6.9	8	53	91	€ 31,20
DH452070	7	8	53	91	€ 31,20
DH452071	7.1	8	53	91	€ 31,20
DH452072	7.2	8	53	91	€ 31,20
DH452073	7.3	8	53	91	€ 31,20
DH452074	7.4	8	53	91	€ 31,20
DH452075	7.5	8	53	91	€ 31,20
DH452076	7.6	8	53	91	€ 31,20
DH452077	7.7	8	53	91	€ 31,20
DH452078	7.8	8	53	91	€ 31,20
DH452079	7.9	8	53	91	€ 31,20
DH452080	8	8	53	91	€ 31,20
DH452081	8.1	10	61	103	€ 37,15
DH452082	8.2	10	61	103	€ 37,15
DH452083	8.3	10	61	103	€ 37,15

Art. nr	D1	D2	L1	L2	Actie prijs
DH452084	8.4	10	61	103	€ 37,15
DH452085	8.5	10	61	103	€ 37,15
DH452086	8.6	10	61	103	€ 37,15
DH452087	8.7	10	61	103	€ 37,15
DH452088	8.8	10	61	103	€ 37,15
DH452089	8.9	10	61	103	€ 37,15
DH452090	9	10	61	103	€ 37,15
DH452091	9.1	10	61	103	€ 37,15
DH452092	9.2	10	61	103	€ 37,15
DH452093	9.3	10	61	103	€ 37,15
DH452094	9.4	10	61	103	€ 37,15
DH452095	9.5	10	61	103	€ 37,15
DH452096	9.6	10	61	103	€ 37,15
DH452097	9.7	10	61	103	€ 37,15
DH452098	9.8	10	61	103	€ 37,15
DH452099	9.9	10	61	103	€ 37,15
DH452100	10	10	61	103	€ 37,15
DH452101	10.1	12	71	118	€ 52,15
DH452102	10.2	12	71	118	€ 52,15
DH452103	10.3	12	71	118	€ 52,15
DH452104	10.4	12	71	118	€ 52,15
DH452105	10.5	12	71	118	€ 52,15
DH452106	10.6	12	71	118	€ 52,15
DH452107	10.7	12	71	118	€ 52,15
DH452108	10.8	12	71	118	€ 52,15
DH452109	10.9	12	71	118	€ 52,15
DH452110	11	12	71	118	€ 52,15
DH452111	11.1	12	71	118	€ 52,15
DH452112	11.2	12	71	118	€ 52,15
DH452113	11.3	12	71	118	€ 52,15
DH452114	11.4	12	71	118	€ 52,15
DH452115	11.5	12	71	118	€ 52,15
DH452116	11.6	12	71	118	€ 52,15
DH452117	11.7	12	71	118	€ 52,15
DH452118	11.8	12	71	118	€ 52,15
DH452119	11.9	12	71	118	€ 52,15
DH452120	12	12	71	118	€ 52,15

Art. nr	D1	D2	L1	L2	Actie prijs
DH452121	12.1	14	77	124	€ 74,10
DH452122	12.2	14	77	124	€ 74,10
DH452123	12.3	14	77	124	€ 74,10
DH452124	12.4	14	77	124	€ 74,10
DH452125	12.5	14	77	124	€ 74,10
DH452126	12.6	14	77	124	€ 74,10
DH452127	12.7	14	77	124	€ 74,10
DH452128	12.8	14	77	124	€ 74,10
DH452129	12.9	14	77	124	€ 74,10
DH452130	13	14	77	124	€ 74,10
DH452131	13.1	14	77	124	€ 74,10
DH452132	13.2	14	77	124	€ 74,10
DH452134	13.4	14	77	124	€ 74,10
DH452135	13.5	14	77	124	€ 74,10
DH452136	13.6	14	77	124	€ 74,10
DH452137	13.7	14	77	124	€ 74,10
DH452138	13.8	14	77	124	€ 74,10
DH452139	13.9	14	77	124	€ 74,10
DH452140	14	14	77	124	€ 74,10
DH452141	14.1	16	83	133	€ 97,95
DH452142	14.2	16	83	133	€ 97,95
DH452145	14.5	16	83	133	€ 97,95
DH452148	14.8	16	83	133	€ 97,95
DH452150	15	16	83	133	€ 97,95
DH452151	15.1	16	83	133	€ 97,95
DH452155	15.5	16	83	133	€ 97,95
DH452158	15.8	16	83	133	€ 97,95
DH452160	16	16	83	133	€ 97,95
DH452165	16.5	18	93	143	€ 146,50
DH452170	17	18	93	143	€ 146,50
DH452175	17.5	18	93	143	€ 146,50
DH452180	18	18	93	143	€ 146,50
DH452185	18.5	20	101	153	€ 167,70
DH452190	19	20	101	153	€ 167,70
DH452195	19.5	20	101	153	€ 167,70
DH452198	19.8	20	101	153	€ 167,70
DH452200	20	20	101	153	€ 167,70

BUITENMICROMETERS



- Meet DIN863-4
- 0-75mm: nauwkeurigheid 0.002mm
- 75-150mm: nauwkeurigheid 0.003mm
- Ratel stop



3203-25A



3203-50A

Artikelnummer	Range	Nauwkeurigheid	Instel ring (inclusief)	L	a	B	Actieprijs
3203-25A*	0-25	±2µm	Ø6mm (inclusief)	32	9	28	€ 18,40
3203-50A*	25-50	±2µm	Ø8mm (inclusief)	57	14	38	€ 23,50
3203-75A*	50-75	±2µm	Ø10mm (inclusief)	82	15	49	€ 30,70
3203-100A*	75-100	±3µm	Ø16mm (inclusief)	107	15	60	€ 34,40
3203-125A	100-125	±3µm	Ø16mm (inclusief)	133	16,5	73	€ 46,80
3203-150A	120-150	±3µm	Ø25mm (inclusief)	158	16,5	85	€ 53,60
3203-175A	150-175	±4µm	Ø25mm (inclusief)	183	19,4	104	€ 67,90
3203-200A	175-200	±4µm	Ø40mm (inclusief)	209	19,4	117	€ 70,70
3203-225A	200-225	±4µm	Ø40mm (inclusief)	234	19,4	130	€ 76,30
3203-250A	225-250	±5µm	Ø62mm (inclusief)	260	19,4	142	€ 88,00
3203-275A	250-275	±5µm	Ø62mm (inclusief)	285	19,4	155	€ 97,90
3203-300A	275-300	±5µm	Ø87mm (inclusief)	310	19,4	168	€ 104,00

Ø61-100 op aanvraag

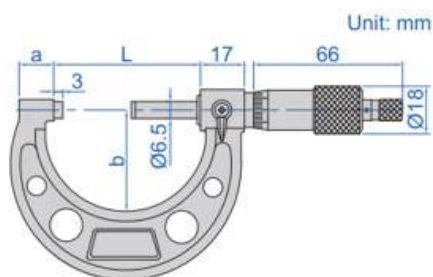

3203-1004A



3203-3006A

Artikelnummer	Range	Inbegrepen micrometers	Verpakking	Actieprijs
3203-753A*	0-75	3203-25A, 3203-50A, 3203-75A	Plastic	€ 86,70
3203-1004A*	0-100	3203-25A, 3203-50A, 3203-75A, 3203-100A	Plastic	€ 110,00
3203-1506A	0-150	3203-25A, 3203-50A, 3203-75A, 3203-100A, 3203-125A, 3203-150A	Plastic	€ 204,00
3203-3006A	150-300	3203-175A, 3203-200A, 3203-225A, 3203-250A, 3203-275A, 3203-300A	Aluminium	€ 490,00
3203-3012A	0-300	3203-25A, 3203-50A, 3203-75A, 3203-100A, 3203-125A, 3203-150A, 3203-175A, 3203-200A, 3203-225A, 3203-250A, 3203-275A, 3203-300A	Aluminium	€ 716,00

*Geleverd met inspectiecertificaat van de fabrikant

3-PUNT BINNENMICROMETER

- Meet DIN863-4
- 6-12mm: nauwkeurigheid 0.001mm
- 12-200mm: nauwkeurigheid 0.005mm
- Ratel stop

IP67
WATERPROOF

INSPECTION
CERTIFICATE



TYPE A



TYPE B



TYPE C

Artikel nummer	Range	Type	Nauwkeurigheid	Instel ring (inclusief)	Verlenghuls	L	A	B	C	Actieprijs
3227-8*	6-8mm	A	4µm	Ø6mm (inclusief)	100mm	54.5	1.5	2.5	-	€ 260,00
3227-10*	8-10mm	A	4µm	Ø8mm (inclusief)	100mm	54.5	1.5	2.5	-	€ 260,00
3227-12*	10-12mm	A	4µm	Ø10mm (inclusief)	100mm	54.5	1.5	2.5	-	€ 260,00
3227-16*	12-16mm	B	4µm	Ø16mm (inclusief)	150mm	80	0.5	6	4.5	€ 207,00
3227-20*	16-20mm	B	4µm	Ø16mm (inclusief)	150mm	80	0.5	6	4.5	€ 207,00
3227-25*	20-25mm	B	4µm	Ø25mm (inclusief)	150mm	90	0.5	8	6	€ 271,00
3227-30*	25-30mm	B	4µm	Ø25mm (inclusief)	150mm	90	0.5	8	6	€ 271,00
3227-40*	30-40mm	B	4µm	Ø40mm (inclusief)	150mm	97	0.5	14	12	€ 309,00
3227-50*	40-50mm	B	5µm	Ø40mm (inclusief)	150mm	97	0.5	14	12	€ 336,00
3227-63*	50-63mm	C	5µm	Ø62mm (inclusief)	150mm	114	0.5	17.5	14.5	€ 373,00
3227-75*	62-75mm	C	5µm	Ø62mm (inclusief)	150mm	114	0.5	17.5	14.5	€ 387,00
3227-88*	75-88mm	C	5µm	Ø87mm (inclusief)	150mm	114	0.5	17.5	14.5	€ 406,00
3227-100*	87-100mm	C	5µm	Ø87mm (inclusief)	150mm	114	0.5	17.5	14.5	€ 426,00
3227-125*	100-125mm	C	5µm	Optie	150mm	140	0.9	29	25	€ 534,00
3227-150*	125-150mm	C	5µm	Optie	150mm	140	0.9	29	25	€ 603,00
3227-175*	150-175mm	C	7µm	Optie	150mm	140	0.9	29	25	€ 669,00
3227-200*	175-200mm	C	7µm	Optie	150mm	140	0.9	29	25	€ 772,00



INSELRING
6-100mm: inclusief
100-200mm: optioneel

VERLENGHULS
inclusief



Artikel nummer	Range	Inbegrepen Micrometers	Instel ring (inclusief)	Verlenghuls (inclusief)	Actieprijs
3227-123*	6-12mm	6-8mm, 8-10mm, 10-12mm	Ø6mm, Ø8mm, Ø10mm	100mm	€ 615,00
3227-202*	12-20mm	12-16mm, 16-20mm	Ø16mm	150mm	€ 360,00
3227-504*	20-50mm	20-25mm, 25-30mm, 30-40mm, 40-50mm	Ø25mm, Ø40mm	150mm	€ 850,00
3227-1004*	50-100mm	50-63mm, 62-75mm, 75-88mm, 87-100mm	Ø62mm, Ø87mm	150mm	€ 1.214,00

*Geleverd met inspectiecertificaat van de fabrikant

IP67 DIGITALE SCHUIFMAAT

- Nauwkeurigheid: $\pm 0.03\text{mm}$
- IP67 stof/waterdicht
- Aflezing: 0.01mm
- Automatisch uitschakelen



1115-150

IP67
WATERPROOF

INSPECTION
CERTIFICATE

Artikel nummer	Range	Nauwkeurigheid	L	A	B	C	D	Actieprijs
1115-150*	0-150	± 0.03	235	20	15	16	40	€ 73,80
1115-200*	0-200	± 0.03	287	24	19	16	50	€ 117,00
1115-300*	0-300	± 0.03	388	26	21	16	60	€ 145,00

PRIJS V.A.
€ 73,80

*Geleverd met inspectiecertificaat van de fabrikant

DIGITALE SCHUIFMAAT

- Nauwkeurigheid: $\pm 0.03\text{mm}$
- Aflezing: 0.01mm
- Automatisch uitschakelen



1136-501

INSPECTION
CERTIFICATE

Artikel nummer	Range	Nauwkeurigheid	L	A	B	C	D	Actieprijs
1136-301*	0-300	± 0.05	42	18	45	24	100	€ 279,00
1136-451*	0-450	± 0.05	625	18	45	24	100	€ 352,00
1136-501*	0-500	± 0.05	675	18	45	24	100	€ 266,00
1136-502*	0-500	± 0.06	675	18	45	24	150	€ 403,00
1136-503*	0-500	± 0.06	675	24	60	31	200	€ 515,00
1136-601*	0-600	± 0.05	770	18	45	24	100	€ 349,00
1136-1002*	0-1000	± 0.08	1220	24	60	31	150	€ 779,00
1136-1502*	0-1500	± 0.11	1780	24	60	42	150	€ 1.655,00
1136-2002*	0-2000	± 0.14	2290	24	60	42	150	€ 2.439,00

PRIJS V.A.
€ 279,-

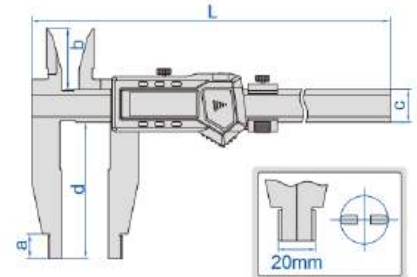

NULPUNT INSTELAPPARAAT

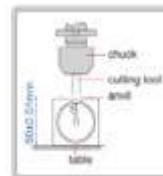

PRIJS
€ 204,-

- Magnetic base

ARTIKELNUMMER	Hoogte (H)	Graduatie	Nauwkeurigheid	Testkracht
2397-502A	50mm	0.01mm	$\pm 0.01\text{mm}$	9N (at 50mm)

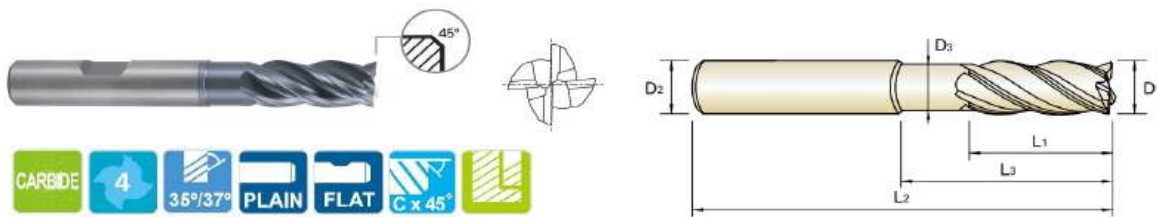

- Speciale geometrie met meervoudige helix elimineren trillingen
- Uitstekende prestaties voor RVS soorten, zacht staal, gietijzer en materialen met een lage/gemiddelde hardheid onder HRc40

Art. nr	D1	D2	D3	L1	L3	L2	Actieprijs
GMF61901	3	6	2.7	7	17	57	€ 17,50
GMF61904	4	6	3.7	11	16	57	€ 17,50
GMF61906	5	6	4.7	13	18	57	€ 17,50
GMF61909	6	6	5.5	13	21	57	€ 17,50
GMF61912	8	8	7.5	19	27	63	€ 25,00
GMF61915	10	10	9.2	22	32	72	€ 39,50
GMF61918	12	12	11	26	38	83	€ 54,50
GMF61921	16	16	15	32	44	92	€ 93,00
GMF61924	20	20	19	38	54	104	€ 165,00

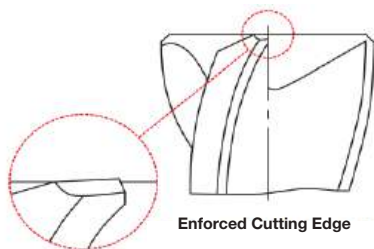

SCAN DE QR CODE VOOR DE SNIJGEGEVENS

GMF61SET5
6 + 8 + 10 + 12 + 16mm

ACTIE
€215,-

◎ : Excellent ○ : Good

ISO	P										M				K					
	Non-alloy steel					Low alloy steel					High alloyed steel, and tool steel				Stainless steel		Grey cast iron		Nodular cast iron	
Material Description	1	2	3	4	5	6	7	8	9	10	11	12	13	14	15	16	17	18	19	20
VDI 3323	13	25	28	32	10	29	32	38	15	35	15	23	10	10	26	3	25	19	21	
HRc	125	190	250	270	300	180	275	300	350	200	325	200	240	180	180	260	160	250	130	230
Recommended	◎	◎	◎	◎	◎	◎	◎	◎	◎	◎	◎	◎	◎	◎	◎	◎	◎	◎	◎	◎

ISO	N										S						H				
	Aluminum-wrought alloy		Aluminum-cast, alloyed			Copper and Copper Alloys (Bronze / Brass)			Non Metallic Materials		Heat Resistant Super Alloys						Titanium Alloys		Hardened steel	Chilled Cast Iron	Hardened Cast Iron
Material Description	21	22	23	24	25	26	27	28	29	30	31	32	33	34	35	36	37	38	39	40	41
VDI 3323	15	30	25	38	34						200	280	250	350	320	400 Rm	1050 Rm	550	630	400	550
HRc	60	100	75	90	130	110	90	100													
Recommended											○	○	○	○	○	○	○				



- Speciale geometrie met meervoudige helix elimineren trillingen
- Uitstekende prestaties voor RVS soorten, zacht staal, gietijzer en materialen met een lage/gemiddelde hardheid onder HRC40

Art. nr	D1	R	D3	L1	L3	L2	Actieprijs	Art. nr	D1	R	D3	L1	L3	L2	Actieprijs
GMF63030	3	R0.3	6	7	12	54	€ 19,55	GMF63922	8	R1	8	12	46	90	€ 32,30
GMF63040	4	R0.3	6	8	15	57	€ 19,55	GMF63923	10	R1	10	14	25	72	€ 42,80
GMF63050	5	R0.3	6	10	17	57	€ 19,55	GMF63924	10	R0.5	10	14	35	82	€ 48,80
GMF63060	6	R0.3	6	10	15	57	€ 19,55	GMF63925	10	R1	10	14	35	82	€ 48,80
GMF63080	8	R0.5	8	12	20	63	€ 27,15	GMF63926	10	R0.5	10	14	55	102	€ 51,35
GMF63100	10	R0.5	10	14	25	72	€ 42,80	GMF63927	10	R1	10	14	55	102	€ 51,35
GMF63120	12	R0.5	12	16	30	83	€ 58,35	GMF63928	12	R1	12	16	30	83	€ 58,35
GMF63160	16	R1	16	22	38	92	€ 92,20	GMF63929	12	R2	12	16	30	83	€ 58,35
GMF63200	20	R1	20	26	50	104	€ 165,55	GMF63930	12	R0.5	12	16	40	93	€ 61,15
GMF63901	3	R0.5	6	7	12	54	€ 19,55	GMF63931	12	R1	12	16	40	93	€ 61,15
GMF63902	3	R0.3	6	7	17	57	€ 19,55	GMF63932	12	R2	12	16	40	93	€ 61,15
GMF63903	3	R0.5	6	7	17	57	€ 19,55	GMF63933	12	R0.5	12	16	64	117	€ 78,20
GMF63904	4	R0.5	6	8	15	57	€ 19,55	GMF63934	12	R1	12	16	64	117	€ 78,20
GMF63905	4	R0.3	6	8	22	63	€ 19,55	GMF63935	12	R2	12	16	64	117	€ 78,20
GMF63906	4	R0.5	6	8	22	63	€ 19,55	GMF63936	16	R2	16	22	38	92	€ 92,20
GMF63907	5	R0.5	6	10	17	57	€ 19,55	GMF63937	16	R3	16	22	38	92	€ 92,20
GMF63908	5	R0.3	6	10	27	67	€ 19,55	GMF63938	16	R1	16	22	55	109	€ 117,00
GMF63909	5	R0.5	6	10	27	67	€ 19,55	GMF63939	16	R2	16	22	55	109	€ 117,00
GMF63910	6	R0.5	6	10	15	57	€ 19,55	GMF63940	16	R3	16	22	55	109	€ 117,00
GMF63911	6	R1	6	10	15	57	€ 19,55	GMF63941	16	R1	16	22	87	141	€ 126,30
GMF63912	6	R0.3	6	10	20	62	€ 19,55	GMF63942	16	R2	16	22	87	141	€ 126,30
GMF63913	6	R0.5	6	10	20	62	€ 19,55	GMF63943	16	R3	16	22	87	141	€ 126,30
GMF63914	6	R1	6	10	20	62	€ 19,55	GMF63944	20	R2	20	26	50	104	€ 165,55
GMF63915	6	R0.3	6	10	32	74	€ 19,55	GMF63945	20	R3	20	26	50	104	€ 165,55
GMF63916	6	R0.5	6	10	32	74	€ 19,55	GMF63946	20	R1	20	26	70	124	€ 210,85
GMF63917	6	R1	6	10	32	74	€ 19,55	GMF63947	20	R2	20	26	70	124	€ 210,85
GMF63918	8	R1	8	12	20	63	€ 27,15	GMF63948	20	R3	20	26	70	124	€ 210,85
GMF63919	8	R0.5	8	12	30	73	€ 30,00	GMF63949	20	R1	20	26	110	164	€ 244,75
GMF63920	8	R1	8	12	30	73	€ 30,00	GMF63950	20	R2	20	26	110	164	€ 244,75
GMF63921	8	R0.5	8	12	46	90	€ 32,30	GMF63951	20	R3	20	26	110	164	€ 244,75

◎ : Excellent ○ : Good

ISO Material Description	P										M					K				
	Non-alloy steel					Low alloy steel					High alloyed steel and tool steel			Stainless steel		Grey cast iron		Nodular cast iron		Malleable cast iron
VDI 3323	1	2	3	4	5	6	7	8	9	10	11	12	13	14	15	16	17	18	19	20
HRC	13	25	28	32	38	10	29	32	38	15	35	15	23	10	10	26	3	25	21	21
HB	125	190	250	270	300	180	275	300	350	200	325	200	240	180	180	260	160	250	130	230
Recommended	◎	◎	◎	◎	◎	◎	◎	◎	◎	◎	◎	◎	◎	◎	◎	◎	◎	◎	◎	◎

ISO Material Description	N										S										H					
	Aluminum- wrought alloy		Aluminum-cast, alloyed			Copper and Copper Alloys (Bronze / Brass)					Non Metallic Materials		Heat Resistant Super Alloys					Titanium Alloys			Hardened steel	Chilled Cast Iron	Hardened Cast Iron			
VDI 3323	21	22	23	24	25	26	27	28	29	30	31	32	33	34	35	36	37	38	39	40	41					
HRC	60	100	75	90	130	110	90	100			15	30	25	38	34	200	280	250	350	320	400 Rm	1050 Rm	550	630	400	550
Recommended											○	○	○	○	○	○	○	○	○	○	○	○	○	○	○	○

PRODUCTINFORMATIE



DE TOONAANGEVENDE PRODUCTLIJN IN DE WERELD VAN DRAADSNIJDEN!



THREAD TURNING

VARGUS offers an extensive collection of pitches and standards in different grades, IC ranges and types of insert styles, as well as customized methods for the oil and gas industry.

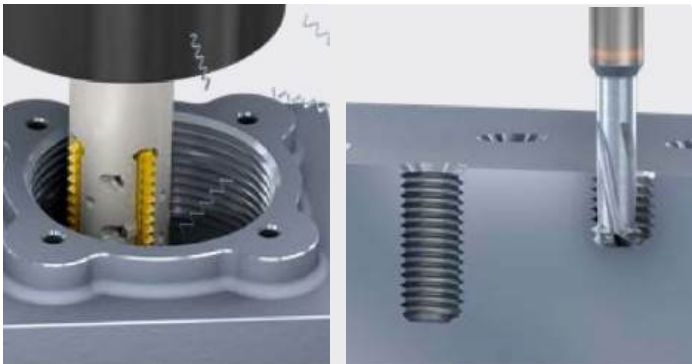

THREAD MILLING

VARGUS provides a wide range of applications and solutions in multi-tooth, single-tooth for deep holes, and solid carbide tools.

FEWER PASSES FOR MACHINING
MACH TT

MACH TT
Supersonic Thread Turning

MACH
Supersonic Threading

UNMATCHED PRODUCTIVITY

MACH TM
Supersonic Thread Milling

HIGH feed
mm/flute
MACH TM



GEAR MILLING

Revolutionary and cost-effective solutions for Gear, Spline & Rack applications, tailor-made to order or available as standard.

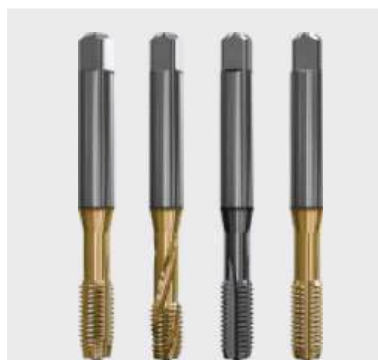

V-TAPS

Advanced tapping solutions for the most popular threading application standards.



V-WHIRLING

High precision whirling system for medical and micromachining applications.

SHAVIV HANDONTBRAMER

EN MESJES TYPE E SET MANGO II



PRODUCTINFORMATIE



Artikelnummer set : 155-90065

PRIJS
€ 19,50

LOSSE MESJES

- Artikelnummer: 151-29034 (VE 10 stuks) - Mesjes E100
- Artikelnummer: 151-29040 (VE 10 stuks) - Mesjes E200
- Artikelnummer: 151-29042 (VE 10 stuks) - Mesjes E300



BISON 3-KLAUWPLATEN ACTIE



Standard Zubehör
(standard accessories)

- 1 Satz harte einteilige Bohrbacken
1 Set of hard outside-inside solid jaws
- 1 Satz harte einteilige Drehbacken
1 Set of hard outside solid jaws
- 1 Schlüssel
1 Wrench



Standard Zubehör
(standard accessories)

- 1 Satz harte einteilige Bohrbacken
1 Set of hard outside inside solid jaws
- 1 Satz harte einteilige Drehbacken
1 Set of hard outside solid jaws
- 1 Schlüssel
1 Wrench

Diameter	Asgat	Artikelnummer Serie 3204	Actieprijs	Artikelnummer Serie 3274	Actieprijs
80	16	3204-80	€ 377,00	3274-80	€ 502,00
100	20	3204-100	€ 429,00	3274-100	€ 556,00
125	32	3204-125	€ 459,00	3274-125	€ 617,00
160	42	3204-160	€ 536,00	3274-160	€ 641,00
200	55	3204-200	€ 674,00	3274-200	€ 693,00
250	76	3204-250	€ 920,00	3274-250	€ 954,00
315	103	3204-315	€ 1.370,00	3274-315	€ 1.492,00
400	136	3204-400	€ 2.749,00	3274-400	€ 3.429,00
500	190	3204-500	€ 4.598,00	3274-500	€ 6.142,00
630	252	3204-630	€ 7.335,00	3274-630	€ 8.653,00

WERKPLAATS UITRUSTING VOOR CNC GEREEDSCHAPPEN

bedrunka+hirth

Workplace up to date – mehr Raum zum Arbeiten

BESTSELLER



BESTSELLER



ACTIEFOLDER



CNC vleugeldeurkast T500 R 36-16 (02.2118.04/3)

- 4 x CNC gereedschapshouderframes kunnen schuin of recht worden gebruikt
- Incl. CNC-gereedschapsinzetstukken
- Deuren van plaatstaal

Artikelnummer	Maatvoering B x D x H	CNC E1	CNC E2	CNC E3
02.2118.04A	980 x 500 x 1838	80/192*	80/132*	52/96*

CNC E1		CNC E2		CNC E3	
49 x 103 x 17 mm		74 x 103 x 17 mm		99 x 103 x 17 mm	
SK 30	SK 40	SK 40	SK 50	SK 50	SK 50
VDI 25	VDI 40	VDI 40	VDI 50	VDI 50	VDI 50
VDI 30	HSK A 50 / B 63	VDI 60	VDI 60	VDI 60	VDI 60
MK3	HSK A 63 / B 80	HSK A 32 / B 40	HSK A 32 / B 40	HSK A 32 / B 40	HSK A 32 / B 40
MK4	MK 5	HSK A 40 / B 50	HSK A 40 / B 50	HSK A 40 / B 50	HSK A 40 / B 50
Capto C 4	Capto C 5	HSK A 80 / B 100	HSK A 80 / B 100	HSK A 80 / B 100	HSK A 80 / B 100
		HSK A 100 / B 125	HSK A 100 / B 125	HSK A 100 / B 125	HSK A 100 / B 125
		Universal	Universal	Universal	Universal
		Capto C 3	Capto C 3	Capto C 3	Capto C 3
		Capto C 6	Capto C 6	Capto C 6	Capto C 6
		Capto C 8	Capto C 8	Capto C 8	Capto C 8



PROMO
€ 1255,-

* 1e getal = aantal meegeleverde inzetstukken voor de maten E1, E2 of E3 | 2e getal = maximaal aantal mogelijke inzetstukken voor de maten E1, E2 of E3.

TOOLMASTER

**DE BESTE, UITERST NAUWKEURIGE IN
ZWITSERLAND GEBOUWDE VOORINSTELLINGS-EN
KRIMPAPPARATEN LEIDEN U NAAR SUCCES!**

Het PWB TOOL MASTER Modular System biedt een professionele oplossing voor het instellen en meten van gereedschappen.

De TOOL MASTER is eenvoudig, snel en veilig te bedienen en levert zeer nauwkeurige resultaten. Met de TOOL MASTER kunt u de efficiëntie en winstgevendheid van uw gereedschapsinstellingen en machinebewerkingen aanzienlijk verbeteren.

Wij garanderen u hogere kwaliteit, verbeterde veiligheid, verhoogde snelheid, verbeterde procesbetrouwbaarheid en minder machine-uitvaltijd.

EVOSET

...for best measuring results



PWB+

UITWISSELBARE 'MINI TOOLS'



PRODUCTINFORMATIE



Patents and Certifications

PATENTED

40 years experiences
30 patents approval
Innovation and global integration
The glory of Taiwan

A collection of various Y.T. mini tools, including different sizes of drill bits and end mills, displayed against a dark, starry background. On the right side, a circular graphic with a glowing blue border contains several small icons of the tools.

SAW BLADE
SLITTING / SLOTTING / CUT-OFF
SERIES

A row of various Y.T. saw blades, including different sizes and types of slitting, slotting, and cut-off blades, displayed against a dark background.

UFO Family
One holder fits differen inserts
up to 400 types

A row of various Y.T. UFO Family tools, including holders and inserts, displayed against a dark background. The text 'One holder fits differen inserts up to 400 types' is prominently featured.



VOLG ONS



WHATSAPP
+31-06-17714749



YOUNG CUTTINGTOOLS BV

Meerheide 100b
5521 DX Eersel
Postbus 60
5520 AB Eersel

Tel. +31 (0)497-820213
Fax +31 (0)497-820214
info@youngcuttingtools.nl
www.youngcuttingtools.nl

Prijzen exclusief BTW, prijzen zijn geldig t/m 30-09-2025 onder voorbehoud van prijswijzigingen en drukfouten.