

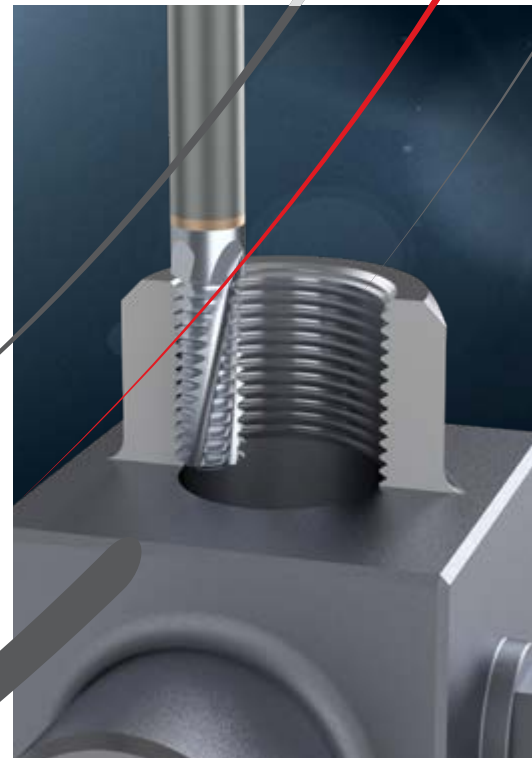

**MACH**  
Supersonic  
Threading

**UNMATCHED  
PRODUCTIVITY**



METRIC

# UNMATCHED PRODUCTIVITY



Features and Innovations .....4

## MACH TT Inserts

Partial Profile 60° .....	6
Partial Profile 55° .....	6
ISO Metric .....	7
American UN .....	8
Whitworth for BSW, BSP .....	9
BSPT .....	10
NPT .....	11
NPTF .....	12
Round (DIN 405) .....	12
Round (DIN 20400) .....	13
Trapez .....	13
American ACME .....	14
Stub ACME .....	14
UNJ .....	15
MJ .....	16
American Buttress .....	16
British Buttress .....	17
Metric Buttress (Sägengewinde) .....	17
API .....	18
API Buttress Casing .....	18
API Round Casing & Tubing .....	19
VAM .....	19
New VAM .....	20
EL-Extreme Line .....	20

## MACH TT External Holders

MACH TT with Coolant (HPC) – 3 Inlets .....	21
MACH TT with Coolant (HPC) – 2 Inlets .....	22
MACH TT for Swiss Type Machines .....	23
MACH TT V-CAP with Coolant (HPC) .....	24
MACH TT .....	24

## MACH TT Internal Holders

MACH TT with Coolant (HPC) .....	25
MACH TT V-CAP with Coolant (HPC) .....	26
MACH TT Smooth Cut System .....	27
Technical Data .....	28
Anvils .....	29



Features and Innovations .....30

## MACH 25 Inserts

API Buttress Casing .....	32
API Round Casing & Tubing .....	33
GOST (OTTM / OTTG) .....	34

## MACH 25 External Holders

MACH TT with Coolant (HPC) .....35

## MACH 25 Internal Holders

MACH TT with Coolant (HPC) .....	35
Technical Data .....	36
Anvils .....	37



Features and Innovations .....38

## MACH TM Solid Tools

ISO Metric .....	40
American UN .....	41
BSP .....	41
NPT .....	42
Technical Data .....	43

# MORE THAN 2 TIMES FASTER



## MACH TT External

Application: M64x3.0x33 | Material: SAE 4140 | Cutting Speed:  $V_c = 100$  m/min

### STANDARD

15 Passes | 40 sec.

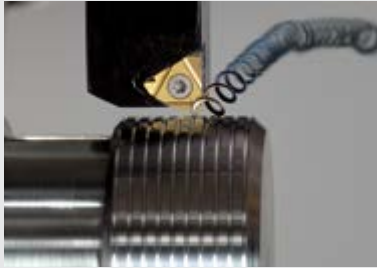

### MACH TT

6 Passes | 15 sec.



60%  
less passes

60%  
less machining time

50%  
more tool life



## MACH TT Internal

Application: M36x2.0x17 | Material: SAE 4140 | Cutting Speed:  $V_c = 100$  m/min

### STANDARD

12 Passes | 13 sec.



### MACH TT

5 Passes | 5 sec.



60%  
less passes

60%  
less machining time

50%  
more tool life



## MACH TM

Application: M10x1.5x20 | Material: SAE 4140 | Cutting Speed:  $V_c = 90$  m/min

### STANDARD (3 Flutes)

feed 0.15 mm/rev | 7 sec.



### MACH TM (4 Flutes)

feed 0.4 mm/rev | 3 sec.



100%  
higher feed (mm/flute)

60%  
less machining time

25%  
more tool life

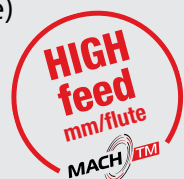



**Now available in:**  
External - IC 3/8" & IC 1/2" | Internal - IC 3/8"

## Features and Innovations

### Improved Rake & Reinforced Geometry

For high resistance with a reduced number of passes

### VK8 Grade

High wear resistance for general purpose applications  
AlTiN + TiN PVD coating

### Improved Profile Design

Superior threading surface finish

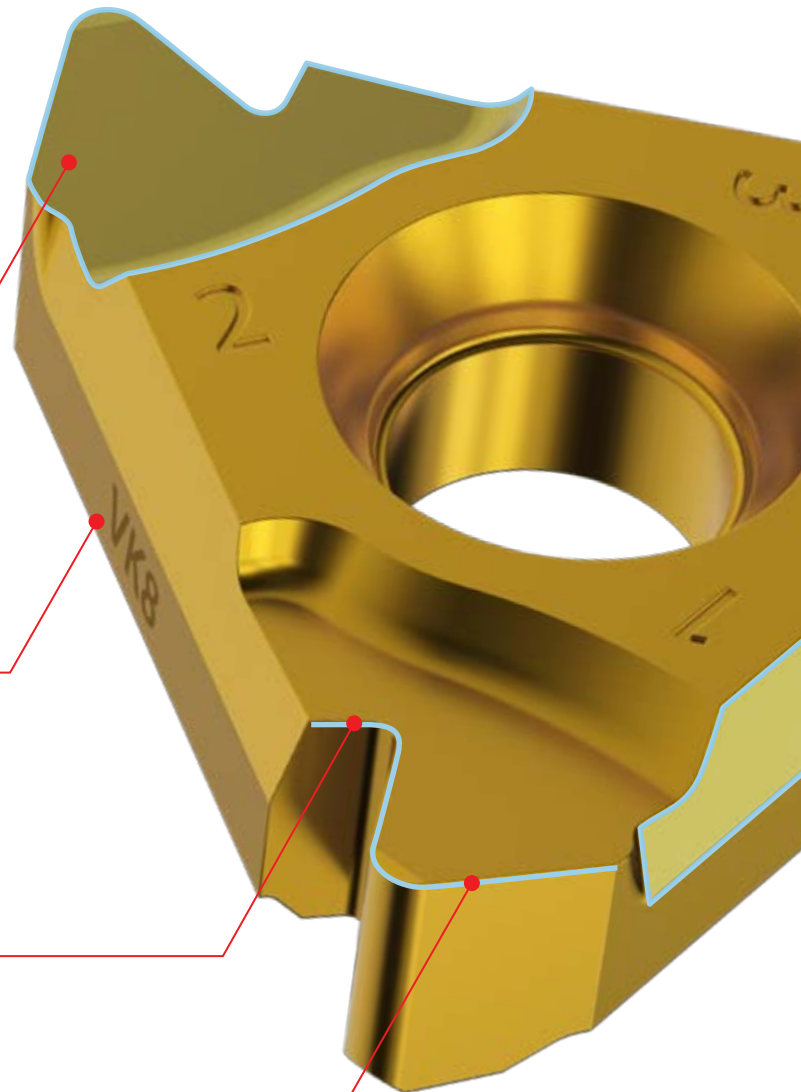
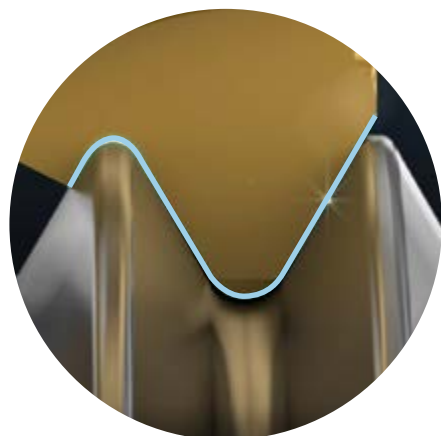

### Advanced Surface Treatment

Reinforced cutting edge and smooth surface finish



# UNMATCHED PRODUCTIVITY

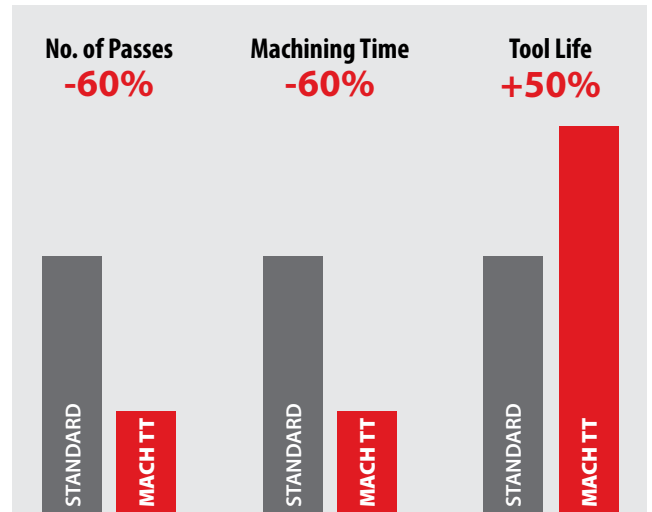

**PATENT PENDING**

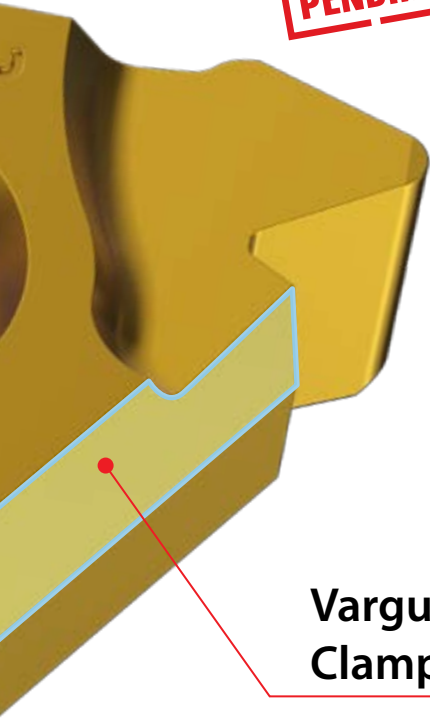

## Vargus Dovetail Clamping System

Super rigid - designed for high loads

## Advantages

- ✓ Significantly reduces the number of passes
- ✓ Dramatically decreases machining time
- ✓ Extended tool life
- ✓ Excellent surface finish
- ✓ Eccentric tool overhang design for deeper threads and improved stability (internal)

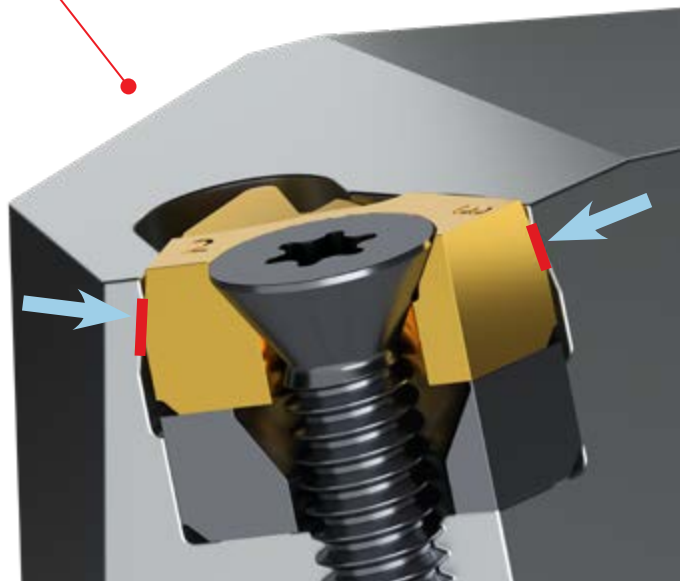

## Partial Profile 60°

### External / Internal

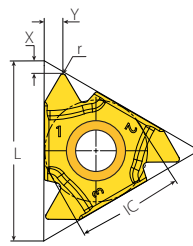
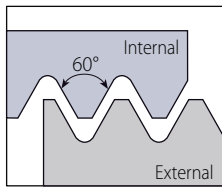

External

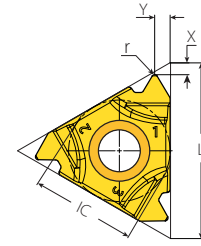

Internal

### External



Insert Size		Pitch		Ordering Code	Market Description	Dimensions mm			Anvil	
IC	L mm	mm	TPI	RH		r	X	Y	RH	Toolholder
3/8"	16	0.5-1.5	48-16	3DTERA60...	16DTERA60...	0.05	1.2	1.2	YE3	AL...-3DT
		1.75-3.0	14-8	3DTERG60...	16DTERG60...	0.27	1.1	1.7		
		0.5-3.0	48-8	3DTERAG60...	16DTERAG60...	0.08	1.1	1.7		
1/2"	22	3.5-5.0	7-5	4DTERN60...	22DTERN60...	0.53	1.8	2.5	YE4	AL...-4DT

### Internal



Insert Size		Pitch		Ordering Code	Market Description	Dimensions mm			Anvil	
IC	L mm	mm	TPI	RH		r	X	Y	RH	Toolholder
3/8"	16	0.5-1.5	48-16	3DTIRA60...	16DTIRA60...	0.05	1.3	1.3	YI3	.VRC...-3DT
		1.75-3.0	14-8	3DTIRG60...	16DTIRG60...	0.16	1.2	1.5		
		0.5-3.0	48-8	3DTIRAG60...	16DTIRAG60...	0.05	1.2	1.5		

## Partial Profile 55°

### External / Internal

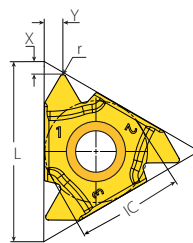
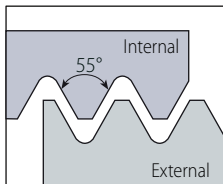

External

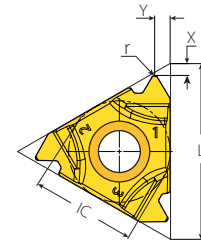

Internal

### External



Insert Size		Pitch		Ordering Code	Market Description	Dimensions mm			Anvil	
IC	L mm	mm	TPI	RH		r	X	Y	RH	Toolholder
3/8"	16	0.5-1.5	48-16	3DTERA55...	16DTERA55...	0.05	1.2	1.2	YE3	AL...-3DT
		1.75-3.0	14-8	3DTERG55...	16DTERG55...	0.21	1.1	1.7		
		0.5-3.0	48-8	3DTERAG55...	16DTERAG55...	0.07	1.1	1.7		
1/2"	22	3.5-5.0	7-5	4DTERN55...	22DTERN55...	0.43	1.8	2.2	YE4	AL...-4DT

### Internal



Insert Size		Pitch		Ordering Code	Market Description	Dimensions mm			Anvil	
IC	L mm	mm	TPI	RH		r	X	Y	RH	Toolholder
3/8"	16	0.5-1.5	48-16	3DTIRA55...	16DTIRA55...	0.05	1.3	1.3	YI3	.VRC...-3DT
		1.75-3.0	14-8	3DTIRG55...	16DTIRG55...	0.21	1.1	1.6		
		0.5-3.0	48-8	3DTIRAG55...	16DTIRAG55...	0.07	1.1	1.7		

# ISO Metric

**External / Internal**

Defined by: DIN 13  
Tolerance class: 6g/6H

**External**

**Internal**

## External

IC	L mm	Pitch mm	Ordering Code RH	Market Description	Dimensions mm			Anvil RH	Toolholder
					h min	X	Y		
3/8"	16	0.7	3DTER0.7ISO...	16DTER0.7ISO...	0.43	1.6	0.5	YE3	AL..-3DT
		0.75	3DTER0.75ISO...	16DTER0.75ISO...	0.46	1.6	0.5		
		0.8	3DTER0.8ISO...	16DTER0.8ISO...	0.49	1.6	0.6		
		1.0	3DTER1.0ISO...	16DTER1.0ISO...	0.61	1.5	0.6		
		1.25	3DTER1.25ISO...	16DTER1.25ISO...	0.77	1.5	0.8		
		1.5	3DTER1.5ISO...	16DTER1.5ISO...	0.92	1.4	0.9		
		1.75	3DTER1.75ISO...	16DTER1.75ISO...	1.07	1.4	1.2		
		2.0	3DTER2.0ISO...	16DTER2.0ISO...	1.23	1.4	1.3		
		2.5	3DTER2.5ISO...	16DTER2.5ISO...	1.53	1.4	1.4		
		3.0	3DTER3.0ISO...	16DTER3.0ISO...	1.84	1.3	1.5		
1/2"	22	3.5	4DTER3.5ISO...	22DTER3.5ISO...	2.15	1.8	2.2	YE4	AL..-4DT
		4.0	4DTER4.0ISO...	22DTER4.0ISO...	2.45	1.8	2.1		
		4.5	4DTER4.5ISO...	22DTER4.5ISO...	2.76	1.7	2.2		
		5.0	4DTER5.0ISO...	22DTER5.0ISO...	3.07	1.7	2.3		
		5.5	4DTER5.5ISO...	22DTER5.5ISO...	3.37	1.9	2.6		
		6.0	4DTER6.0ISO...	22DTER6.0ISO...	3.68	1.8	2.7		

## Internal

IC	L mm	Pitch mm	Ordering Code RH	Market Description	Dimensions mm			Anvil RH	Toolholder
					h min	X	Y		
3/8"	16	0.5	3DTIR0.5ISO...	16DTIR0.5ISO...	0.29	1.5	0.4	YI3	.VRC..-3DT
		0.7	3DTIR0.7ISO...	16DTIR0.7ISO...	0.40	1.4	0.5		
		0.75	3DTIR0.75ISO...	16DTIR0.75ISO...	0.43	1.5	0.5		
		0.8	3DTIR0.8ISO...	16DTIR0.8ISO...	0.46	1.5	0.5		
		1.0	3DTIR1.0ISO...	16DTIR1.0ISO...	0.58	1.3	0.6		
		1.25	3DTIR1.25ISO...	16DTIR1.25ISO...	0.72	1.2	0.7		
		1.5	3DTIR1.5ISO...	16DTIR1.5ISO...	0.87	1.2	0.8		
		1.75	3DTIR1.75ISO...	16DTIR1.75ISO...	1.01	1.2	1.0		
		2.0	3DTIR2.0ISO...	16DTIR2.0ISO...	1.15	1.1	1.3		
		2.5	3DTIR2.5ISO...	16DTIR2.5ISO...	1.44	1.1	1.3		
		3.0	3DTIR3.0ISO...	16DTIR3.0ISO...	1.73	1.1	1.4		
		3.5	3DTIR3.5ISO...	16DTIR3.5ISO...	2.02	1.1	1.5		

# American UN

## External / Internal

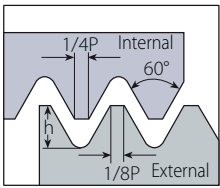

Defined by: ANSI B1.1  
Tolerance class: 2A/2B

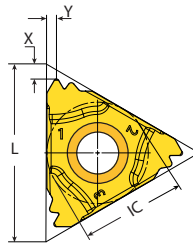

External

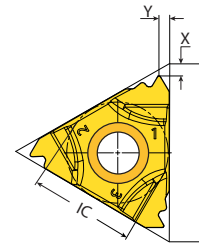

Internal

## External

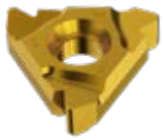

Insert Size		Pitch	Ordering Code	Market Description	Dimensions mm			Anvil	
IC	L mm	TPI	RH		h min	X	Y	RH	Toolholder
3/8"	16	32	3DTER32UN...	16DTER32UN...	0.49	1.6	0.6		
		28	3DTER28UN...	16DTER28UN...	0.56	1.6	0.6		
		27	3DTER27UN...	16DTER27UN...	0.58	1.6	0.6		
		24	3DTER24UN...	16DTER24UN...	0.65	1.5	0.7		
		20	3DTER20UN...	16DTER20UN...	0.78	1.5	0.8		
		18	3DTER18UN...	16DTER18UN...	0.87	1.4	0.8		
		16	3DTER16UN...	16DTER16UN...	0.97	1.4	1.0		
		14	3DTER14UN...	16DTER14UN...	1.11	1.4	1.3	YE3	AL...-3DT
		13	3DTER13UN...	16DTER13UN...	1.20	1.4	1.3		
		12	3DTER12UN...	16DTER12UN...	1.30	1.4	1.4		
		11.5	3DTER11.5UN...	16DTER11.5UN...	1.35	1.4	1.4		
		11	3DTER11UN...	16DTER11UN...	1.42	1.4	1.4		
		10	3DTER10UN...	16DTER10UN...	1.56	1.4	1.7		
		9	3DTER9UN...	16DTER9UN...	1.73	1.4	1.6		
1/2"	22	7	4DTER7UN...	22DTER7UN...	2.22	1.80	2.2		
		6	4DTER6UN...	22DTER6UN...	2.60	1.78	2.1	YE4	AL...-4DT
		5	4DTER5UN...	22DTER5UN...	3.12	1.87	2.5		

## Internal



Insert Size		Pitch	Ordering Code	Market Description	Dimensions mm			Anvil	
IC	L mm	TPI	RH		h min	X	Y	RH	Toolholder
3/8"	16	32	3DTIR32UN...	16DTIR32UN...	0.51	1.4	0.5		
		28	3DTIR28UN...	16DTIR28UN...	0.52	1.5	0.5		
		24	3DTIR24UN...	16DTIR24UN...	0.61	1.4	0.6		
		20	3DTIR20UN...	16DTIR20UN...	0.73	1.2	0.7		
		18	3DTIR18UN...	16DTIR18UN...	0.81	1.2	0.7		
		16	3DTIR16UN...	16DTIR16UN...	0.92	1.2	0.9		
		14	3DTIR14UN...	16DTIR14UN...	1.05	1.2	1.0		
		13	3DTIR13UN...	16DTIR13UN...	1.13	1.2	0.9	YI3	.VRC...-3DT
		12	3DTIR12UN...	16DTIR12UN...	1.22	1.1	1.2		
		11.5	3DTIR11.5UN...	16DTIR11.5UN...	1.28	1.2	1.2		
		11	3DTIR11UN...	16DTIR11UN...	1.33	1.2	1.2		
		10	3DTIR10UN...	16DTIR10UN...	1.47	1.1	1.2		
		9	3DTIR9UN...	16DTIR9UN...	1.63	1.1	1.3		
		8	3DTIR8UN...	16DTIR8UN...	1.83	1.1	1.4		



# Whitworth for BSW, BSP

**External / Internal**

Defined by: B.S.84:1956, DIN 259, ISO228/1:1982  
Tolerance class: Medium class A

**External**                      **Internal**

## External

	Insert Size		Pitch	Ordering Code	Market Description	Dimensions mm			Anvil	
	IC	L mm	TPI	RH		h min	X	Y	RH	Toolholder
	3/8"	16	28	3DTER28W...	16DTER28W...	0.58	1.6	0.6	YE3	AL...3DT
			26	3DTER26W...	16DTER26W...	0.63	1.6	0.6		
			20	3DTER20W...	16DTER20W...	0.81	1.5	0.7		
			19	3DTER19W...	16DTER19W...	0.86	1.5	0.8		
			18	3DTER18W...	16DTER18W...	0.90	1.4	1.0		
			16	3DTER16W...	16DTER16W...	1.02	1.4	1.2		
			14	3DTER14W...	16DTER14W...	1.16	1.4	1.2		
			12	3DTER12W...	16DTER12W...	1.36	1.4	1.3		
			11	3DTER11W...	16DTER11W...	1.48	1.4	1.3		
			10	3DTER10W...	16DTER10W...	1.63	1.4	1.3		
			9	3DTER9W...	16DTER9W...	1.81	1.4	1.7		
			8	3DTER8W...	16DTER8W...	2.03	1.1	1.5		
1/2"	22	7	4DTER7W...	22DTER7W...	2.41	1.8	2.2	YE4	AL...4DT	
		6	4DTER6W...	22DTER6W...	2.71	1.8	2.0			
		5	4DTER5W...	22DTER5W...	3.25	1.7	2.3			

## Internal

	Insert Size		Pitch	Ordering Code	Market Description	Dimensions mm			Anvil	
	IC	L mm	TPI	RH		h min	X	Y	RH	Toolholder
	3/8"	16	28	3DTIR28W...	16DTIR28W...	0.58	1.4	0.6	YI3	.VRC...3DT
			26	3DTIR26W...	16DTIR26W...	0.63	1.3	0.6		
			24	3DTIR24W...	16DTIR24W...	0.68	1.2	0.6		
			20	3DTIR20W...	16DTIR20W...	0.81	1.1	0.7		
			19	3DTIR19W...	16DTIR19W...	0.86	1.1	0.8		
			18	3DTIR18W...	16DTIR18W...	0.90	1.1	0.8		
			16	3DTIR16W...	16DTIR16W...	1.02	1.1	0.9		
			14	3DTIR14W...	16DTIR14W...	1.16	1.1	0.9		
			12	3DTIR12W...	16DTIR12W...	1.36	1.1	1.3		
			11	3DTIR11W...	16DTIR11W...	1.48	1.1	1.2		
			10	3DTIR10W...	16DTIR10W...	1.63	1.0	1.3		
			9	3DTIR9W...	16DTIR9W...	1.81	1.0	1.4		
8	3DTIR8W...	16DTIR8W...	2.03	1.0	1.5					

# BSPT

## External / Internal

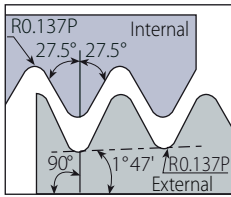

Defined by: B.S. 21:1985  
Tolerance class: Standard BSPT

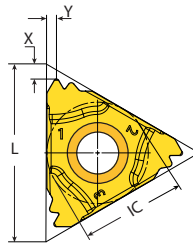

External

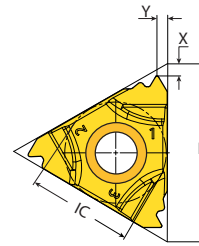

Internal

## External

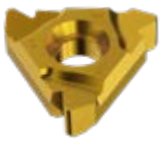

Insert Size		Ordering Code		Market Description	Dimensions mm			Anvil	
IC	L mm	TPI	RH		h min	X	Y	RH	Toolholder
3/8"	16	28	3DTER28BSPT...	16DTER28BSPT...	0.58	1.6	0.6	YE3	AL..-3DT
		19	3DTER19BSPT...	16DTER19BSPT...	0.86	1.2	0.8		
		14	3DTER14BSPT...	16DTER14BSPT...	1.16	1.4	1.3		
		11	3DTER11BSPT...	16DTER11BSPT...	1.48	1.4	1.5		

## Internal



Insert Size		Ordering Code		Market Description	Dimensions mm			Anvil	
IC	L mm	TPI	RH		h min	X	Y	RH	Toolholder
3/8"	16	28	3DTER28BSPT...	16DTIR28BSPT...	0.58	1.3	0.6	YI3	.VRC..-3DT
		19	3DTER19BSPT...	16DTIR19BSPT...	0.86	1.2	0.8		
		14	3DTER14BSPT...	16DTIR14BSPT...	1.16	1.1	1.2		
		11	3DTER11BSPT...	16DTIR11BSPT...	1.48	1.1	1.2		

# NPT

## External / Internal

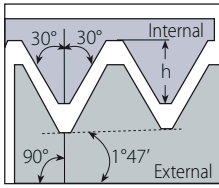

Defined by: ANSI B1.20.1-1983  
Tolerance class: Standard NPT

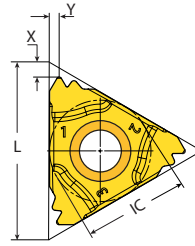

External

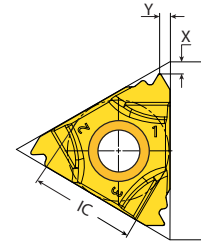

Internal

## External



IC	Insert Size		Pitch	Ordering Code	Market Description	Dimensions mm			Anvil	
	L mm	TPI	RH			h min	X	Y	RH	Toolholder
3/8"	16	27	3DTER27NPT...	16DTER27NPT...	0.66	1.6	0.8	RH	Toolholder	
		18	3DTER18NPT...	16DTER18NPT...	1.01	1.2	0.9			
		14	3DTER14NPT...	16DTER14NPT...	1.33	1.2	1.2	YE3	AL...-3DT	
		11.5	3DTER11.5NPT...	16DTER11.5NPT...	1.64	1.2	1.4			
		8	3DTER8NPT...	16DTER8NPT...	2.42	1.2	1.8			

## Internal



IC	Insert Size		Pitch	Ordering Code	Market Description	Dimensions mm			Anvil	
	L mm	TPI	RH			h min	X	Y	RH	Toolholder
3/8"	16	27	3DTIR27NPT...	16DTIR27NPT...	0.66	1.3	0.6	RH	Toolholder	
		18	3DTIR18NPT...	16DTIR18NPT...	1.01	1.1	1.0			
		14	3DTIR14NPT...	16DTIR14NPT...	1.33	1.2	1.2	YI3	.VRC...-3DT	
		11.5	3DTIR11.5NPT...	16DTIR11.5NPT...	1.64	1.2	1.3			
		8	3DTIR8NPT...	16DTIR8NPT...	2.42	1.2	1.7			

# NPTF

## External / Internal

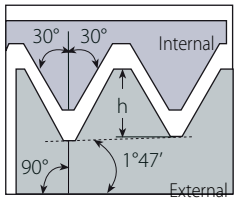

Defined by: ANSI B1.20.3-1976  
Tolerance class: Standard NPTF

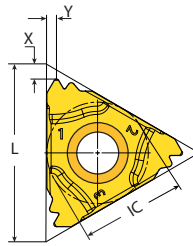

External

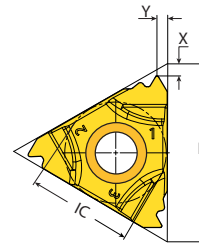

Internal

## External



Insert Size		Pitch	Ordering Code	Market Description	Dimensions mm			Anvil	
IC	L mm	TPI	RH		h min	X	Y	RH	Toolholder
3/8"	16	27	3DTER27NPTF...	16DTER27NPTF...	0.64	1.6	0.8	YE3	AL...3DT
		18	3DTER18NPTF...	16DTER18NPTF...	1.00	1.5	1.4		
		14	3DTER14NPTF...	16DTER14NPTF...	1.35	1.2	1.2		
		11.5	3DTER11.5NPTF...	16DTER11.5NPTF...	1.63	1.2	1.3		
		8	3DTER8NPTF...	16DTER8NPTF...	2.38	1.2	1.7		

## Internal



Insert Size		Pitch	Ordering Code	Market Description	Dimensions mm			Anvil	
IC	L mm	TPI	RH		h min	X	Y	RH	Toolholder
3/8"	16	27	3DTER27NPTF...	16DTER27NPTF...	0.64	1.3	0.6	YI3	.VRC...3DT
		18	3DTER18NPTF...	16DTER18NPTF...	1.00	1.2	1.0		
		14	3DTER14NPTF...	16DTER14NPTF...	1.35	1.2	1.0		
		11.5	3DTER11.5NPTF...	16DTER11.5NPTF...	1.63	1.2	1.3		
		8	3DTER8NPTF...	16DTER8NPTF...	2.38	1.2	1.7		

# Round (DIN 405)

## External

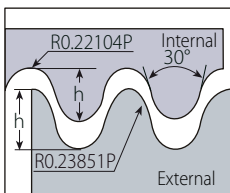

Defined by: DIN 405  
Tolerance class: 7h/7H

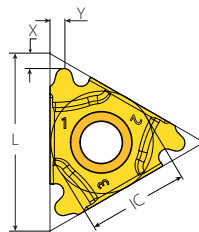

External

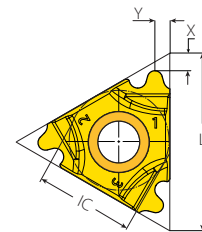

Internal

## External



Insert Size		Pitch	Ordering Code	Market Description	Dimensions mm			Anvil	
IC	L mm	TPI	RH		h min	X	Y	RH	Toolholder
3/8"	16	8	3DTER8RD...	16DTER8RD...	1.59	1.5	1.3	YE3	AL...3DT
		6	3DTER6RD...	16DTER6RD...	2.12	1.3	1.5		
1/2"	22	6	4DTER6RD...	22DTER6RD...	2.12	2.2	2.0	YE4	AL...4DT
		4	4DTER4RD...	22DTER4RD...	3.18	2.2	1.9		

## Internal



Insert Size		Pitch	Ordering Code	Market Description	Dimensions mm			Anvil	
IC	L mm	TPI	RH		h min	X	Y	RH	Toolholder
3/8"	16	8	3DTER8RD...	16DTER8RD...	1.59	1.6	1.4	YI3	.VRC...3DT

## Round (DIN 20400)

### External

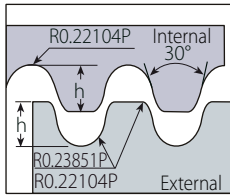

Defined by: DIN 20400  
Tolerance class: Standard

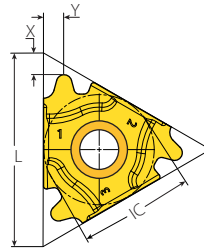

External

### External



Insert Size		Pitch	Ordering Code	Market Description	Dimensions mm			Anvil	
IC	L mm	mm	RH		h min	X	Y	RH	Toolholder
1/2"	22	3	4DTER3.ORD20400...	22DTER3.ORD20400...	1.65	2.1	2.1	YE4	AL...4DT
		4	4DTER4.ORD20400...	22DTER4.ORD20400...	2.20	2.4	2.4		
		5	4DTER5.ORD20400...	22DTER5.ORD20400...	2.75	2.2	2.1		
		6	4DTER6.ORD20400...	22DTER6.ORD20400...	3.30	2.2	2.1		

## Trapez

### External / Internal

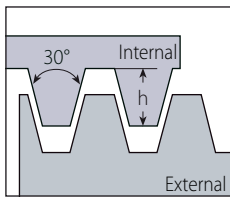

Defined by: DIN 103  
Tolerance class: 7e

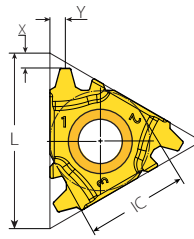

External

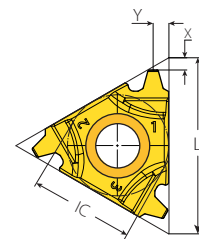

Internal

### External



Insert Size		Pitch	Ordering Code	Market Description	Dimensions mm			Anvil	
IC	L mm	mm	RH		h min	X	Y	RH	Toolholder
3/8"	16	1.5	3DTER1.5TR...	16DTER1.5TR...	0.90	1.2	1.1	YE3	AL...3DT
		2.0	3DTER2.0TR...	16DTER2.0TR...	1.25	1.2	1.3		
		3.0	3DTER3.0TR...	16DTER3.0TR...	1.75	1.2	1.5		
1/2"	22	4.0	4DTER4.0TR...	22DTER4.0TR...	2.25	1.9	2.2	YE4	AL...4DT
		5.0	4DTER5.0TR...	22DTER5.0TR...	2.75	1.9	2.2		
		6.0	4DTER6.0TR...	22DTER6.0TR...	3.50	1.8	2.0		

### Internal



Insert Size		Pitch	Ordering Code	Market Description	Dimensions mm			Anvil	
IC	L mm	mm	RH		h min	X	Y	RH	Toolholder
3/8"	16	1.5	3DTIR1.5TR...	16DTIR1.5TR...	0.90	1.2	1.1	YB3	.VRC...3DT
		2.0	3DTIR2.0TR...	16DTIR2.0TR...	1.25	1.1	1.2		
		3.0	3DTIR3.0TR...	16DTIR3.0TR...	1.75	1.1	1.5		

## American ACME

### External

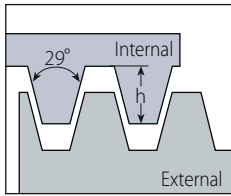

Defined by: ANSI B1.5:1988  
Tolerance class: 3G

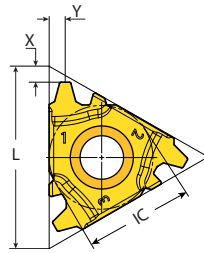

External

### External



Insert Size		Pitch	Ordering Code	Market Description	Dimensions mm			Anvil	
IC	L mm	TPI	RH		h min	X	Y	RH	Toolholder
1/2"	22	7	4DTER7ACME...	22DTER7ACME...	2.08	2.1	2.2	YE4	AL..-4DT
		6	4DTER6ACME...	22DTER6ACME...	2.37	1.9	2.1		
		5	4DTER5ACME...	22DTER5ACME...	2.79	1.9	2.2		

## Stub ACME

### External

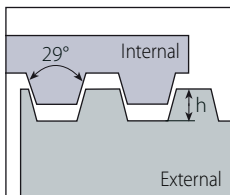

Defined by: ANSI B1.8:1988  
Tolerance class: 2G

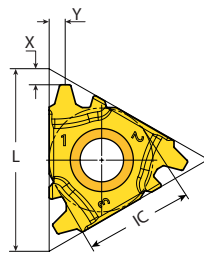

External

### External



Insert Size		Ordering Code	Market Description	Dimensions mm			Anvil		
IC	L mm	TPI	RH		h min	X	Y	RH	Toolholder
1/2"	22	6	4DTER6STACME...	22DTER6STACME...	1.52	2.1	1.8	YE4	AL..-4DT
		5	4DTER5STACME...	22DTER5STACME...	1.78	2.1	2.0		
		4	4DTER4STACME...	22DTER4STACME...	2.16	2.1	2.1		

# UNJ

## External / Internal

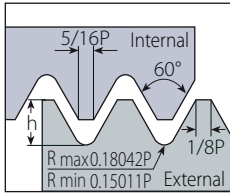

Defined by: MIL-S-8879C  
Tolerance class: 3A/3B

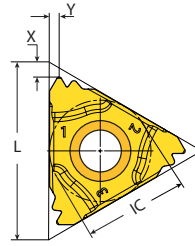

External

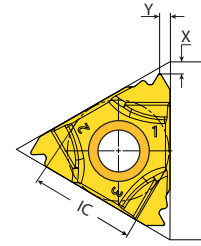

Internal

## External

	Insert Size		Pitch	Ordering Code	Market Description	Dimensions mm			Anvil	
	IC	L mm	TPI	RH		h min	X	Y	RH	Toolholder
	3/8"	16	32	3DTER32UNJ...	16DTER32UNJ...	0.46	1.6	0.6	YE3	AL..3DT
			28	3DTER28UNJ...	16DTER28UNJ...	0.52	1.5	0.6		
			24	3DTER24UNJ...	16DTER24UNJ...	0.61	1.5	0.7		
			20	3DTER20UNJ...	16DTER20UNJ...	0.73	1.5	0.8		
			18	3DTER18UNJ...	16DTER18UNJ...	0.81	1.4	0.8		
			16	3DTER16UNJ...	16DTER16UNJ...	0.92	1.4	0.9		
			14	3DTER14UNJ...	16DTER14UNJ...	1.05	1.4	1.2		
			13	3DTER13UNJ...	16DTER13UNJ...	1.13	1.4	1.2		
			12	3DTER12UNJ...	16DTER12UNJ...	1.22	1.4	1.2		
			10	3DTER10UNJ...	16DTER10UNJ...	1.47	1.4	1.2		
1/2"	22	7	4DTER7UNJ...	22DTER7UNJ...	2.09	1.9	2.1	YE4	AL..4DT	
		6	4DTER6UNJ...	22DTER6UNJ...	2.44	1.9	2.1			
		5	4DTER5UNJ...	22DTER5UNJ...	2.93	1.8	2.4			

## Internal

	Insert Size		Pitch	Ordering Code	Market Description	Dimensions mm			Anvil	
	IC	L mm	TPI	RH		h min	X	Y	RH	Toolholder
	3/8"	16	32	3DTIR32UNJ...	16DTIR32UNJ...	0.42	1.4	0.5	Y13	.VRC..-3DT
			28	3DTIR28UNJ...	16DTIR28UNJ...	0.47	1.4	0.5		
			24	3DTIR24UNJ...	16DTIR24UNJ...	0.55	1.3	0.5		
			20	3DTIR20UNJ...	16DTIR20UNJ...	0.66	1.3	0.6		
			18	3DTIR18UNJ...	16DTIR18UNJ...	0.74	1.3	0.7		
			16	3DTIR16UNJ...	16DTIR16UNJ...	0.83	1.3	1.0		
			14	3DTIR14UNJ...	16DTIR14UNJ...	0.95	1.3	1.0		
			12	3DTIR12UNJ...	16DTIR12UNJ...	1.11	1.2	1.2		

# MJ

## External / Internal

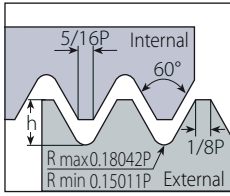

Defined by: ISO 5855  
Tolerance class: 4h/6h-4H/5H

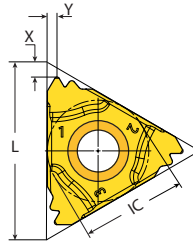

External

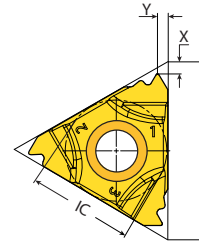

Internal

## External

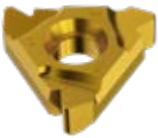

Insert Size		Pitch	Ordering Code	Market Description	Dimensions mm			Anvil	
IC	L mm	mm	RH		h min	X	Y	RH	Toolholder
3/8"	16	1.0	3DTER1.0MJ...	16DTER1.0MJ...	0.58	1.5	0.6	YE3	AL...-3DT
		1.5	3DTER1.5MJ...	16DTER1.5MJ...	0.87	1.4	0.9		
		2.0	3DTER2.0MJ...	16DTER2.0MJ...	1.15	1.39	1.20		
		3.0	3DTER3.0MJ...	16DTER3.0MJ...	1.73	1.32	1.50		

## Internal



Insert Size		Pitch	Ordering Code	Market Description	Dimensions mm			Anvil	
IC	L mm	mm	RH		h min	X	Y	RH	Toolholder
3/8"	16	1.0	3DTIR1.0MJ...	16DTIR1.0MJ...	0.49	1.4	0.5	Y13	.VRC...-3DT
		1.5	3DTIR1.5MJ...	16DTIR1.5MJ...	0.73	1.3	1.0		
		2.0	3DTIR2.0MJ...	16DTIR2.0MJ...	0.97	1.3	1.0		
		3.0	3DTIR3.0MJ...	16DTIR3.0MJ...	1.46	1.15	1.15		

## American Buttress

### External

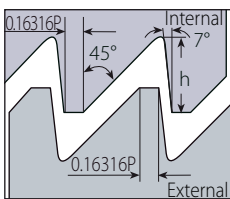

Defined by: ANSI B1.9.1973  
Tolerance class: Class 2

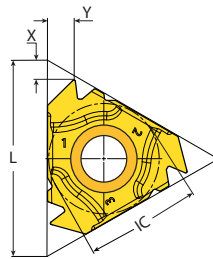

External

## External



Insert Size		Pitch	Ordering Code	Market Description	Dimensions mm			Anvil	
IC	L mm	TPI	RH		h min	X	Y	RH	Toolholder
1/2"	22	8	4DTER8ABUT...	22DTER8ABUT...	2.10	2.1	3.1	YE4	AL...-4DT
		6	4DTER6ABUT...	22DTER6ABUT...	2.80	2.1	3.4		



## British Buttress

### External

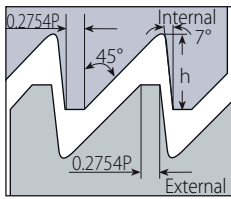

Defined by: B.S. 1657: 1950  
Tolerance class: Medium Class

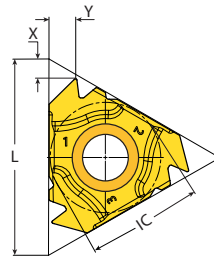

External

### External



Insert Size		Ordering Code	Market Description	Dimensions mm			Anvil		
IC	L mm	TPI	RH	h min	X	Y	RH	Toolholder	
1/2"	22	8	4DTER8BBUT..	22DTER8BBUT.....	1.61	1.84	2.60	YE4	AL...4DT

## Metric Buttress (Sägewinde)

### External / Internal

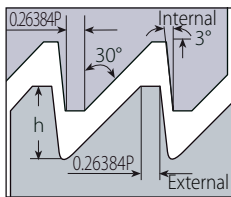

Defined by: DIN 513  
Tolerance class: Medium Class

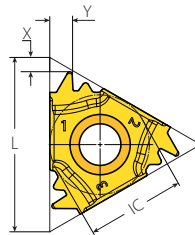

External

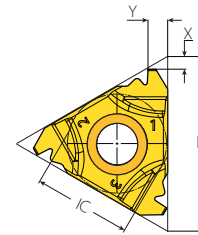

Internal

### External



Insert Size		Pitch	Ordering Code	Market Description	Dimensions mm			Anvil	
IC	L mm	mm	RH		h min	X	Y	RH	Toolholder
3/8"	16	2.0	3DTER2.0SAGE...	16DTER2.0SAGE...	1.74	1.3	2.1	YE3	AL...3DT
		2.0	4DTER2.0SAGE...	22DTER2.0SAGE...	1.74	1.9	2.9		
1/2"	22	3.0	4DTER3.0SAGE...	22DTER3.0SAGE...	2.60	1.8	3.2	YE4	AL...4DT
		4.0	4DTER4.0SAGE...	22DTER4.0SAGE...	3.55	1.7	3.1		

### Internal



Insert Size		Pitch	Ordering Code	Market Description	Dimensions mm			Anvil	
IC	L mm	mm	RH		h min	X	Y	RH	Toolholder
3/8"	16	2.0	3DTER2.0SAGE...	16DTER2.0SAGE...	1.50	1.2	1.8	YI3	.VRC...3DT

# API

## External

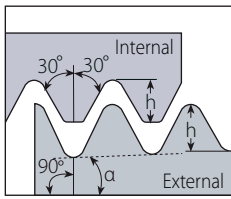

$$\alpha = \arctg (IPF/24)$$

Defined by: API SPEC. 7:1990  
Tolerance class: Standard API

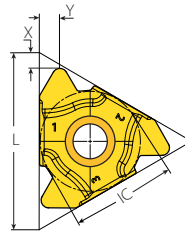

External

## External



IC	L mm	TPI	IPF	RH	Ordering Code	Market Description	Size	Dimensions mm			Anvil	Toolholder
								h min	X	Y		
1/2"	22	4	V-0.038R	2	4DTER4API382...	22DTER4API382...	NC23-NC50, 2 3/8", 6 5/8" IF	3.09	1.8	2.6	YEI 4-API-1P or YE4	AL...-4DT
		4	V-0.038R	3	4DTER4API383...	22DTER4API383...	NC56-NC77	3.08	1.9	2.6		
		5	V-0.040	3	4DTER5API403...	22DTER5API403...	2 3/8"-4 1/2" REG	2.99	1.8	2.4		
		4	V-0.050	2	4DTER4API502...	22DTER4API502...	6 5/8" REG, 5 1/2" FH, 6 5/8" FH	3.75	1.7	2.7		
		4	V-0.050	3	4DTER4API503...	22DTER4API503...	5 1/2", 7 5/8", 8 5/8" REG	3.74	1.7	2.7		
		6	V-0.055	1.5	4DTER6API551...	22DTER6API551...	NC10-NC16	1.41	1.8	2.6		

# API Buttress Casing

## External

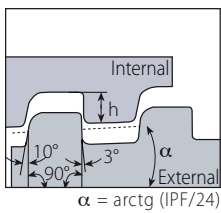

$$\alpha = \arctg (IPF/24)$$

Defined by: STD.5B.1979  
Tolerance class: Standard API

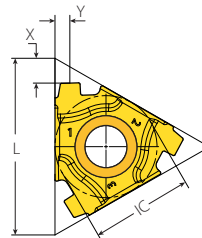

External

## External



IC	L mm	TPI	IPF	RH	Ordering Code	Market Description	Size	Dimensions mm			Anvil	Toolholder
								h min	X	Y		
1/2"	22	5	0.75		4DTER5BUT75...	22DTER5BUT75...	4 1/2"-13 3/8"	1.55	3.1	1.9	YEI 4-BUT or YE4	AL...-4DT
		5	1		4DTER5BUT1...	22DTER5BUT1...	16"-20"	1.55	3.1	1.9		



# API Round Casing & Tubing

**External / Internal**

Defined by: API SPEC. 5B  
Tolerance class: Standard API RD

**External**

**Internal**

## External



Insert Size		Pitch	Ordering Code	Market Description	Dimensions mm			Anvil	
IC	L mm	TPI	RH		h min	X	Y	RH	Toolholder
3/8"	16	10	3DTER10APIRD...	16DTER10APIRD...	1.41	1.4	1.5	YE3	AL...3DT
		8	3DTER8APIRD...	16DTER8APIRD...	1.81	1.4	1.6		

## Internal



Insert Size		Pitch	Ordering Code	Market Description	Dimensions mm			Anvil	
IC	L mm	TPI	RH		h min	X	Y	RH	Toolholder
3/8"	16	10	3DTER10APIRD...	16DTER10APIRD...	1.41	1.1	1.3	Y13	.VRC...3DT
		8	3DTER8APIRD...	16DTER8APIRD...	1.81	1.1	1.5		

## VAM

**External**

Defined by: VAM  
Tolerance class: Standard VAM

**External**

## External



Insert Size		Pitch	Taper	Ordering Code	Market Description	Size	Dimensions mm			Anvil	
IC	L mm	TPI	IPF	RH			h min	X	Y	RH	Toolholder
1/2"	22	6	0.75	4DTER6VAM...	22DTER6VAM...	3 1/2"	0.97	2.1	1.9	YE4	AL...4DT
	22	5	0.75	4DTER5VAM...	22DTER5VAM...	5"-9 5/8"	1.55	3.1	1.9		



## New VAM

### External

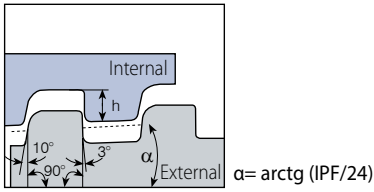

Defined by: VAM  
Tolerance class: Standard VAM

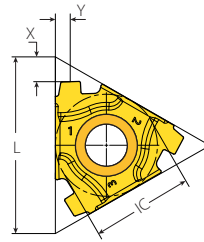

External

### External



Insert Size		Pitch	Taper	Ordering Code	Market Description	Size	Dimensions mm			Anvil	
IC	L mm	TPI	IPF	RH			h min	X	Y	RH	Toolholder
1/2"	22	6	0.75	4DTER6NVAM...	22DTER6NVAM...	3 1/2"	0.97	2.1	1.9	YE4	AL..-4DT
		5	0.75	4DTER5NVAM...	22DTER5NVAM...	5"-9 5/8"	1.55	3.1	2.0		

## EL-Extreme Line

### External

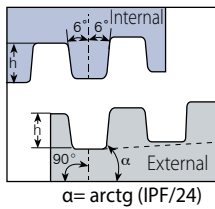

Defined by: API STD,5B:1979  
Tolerance class: Standard

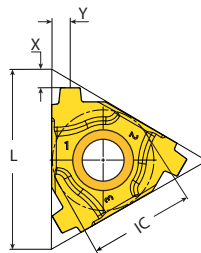

External

### External



Insert Size		Pitch	Taper	Ordering Code	Market Description	Size	Dimensions mm			Anvil	
IC	L mm	TPI	IPF	RH			h min	X	Y	RH	Toolholder
1/2"	22	6	1.5	4DTER6EL15...	22DTER6EL15...	5"-7 5/8"	1.21	2.1	1.9	YE4	AL..-4DT
		5	1.25	4DTER5EL125...	22DTER5EL125...	8 5/8"-10 3/4"	1.71	2.1	2.3		

## External Toolholders

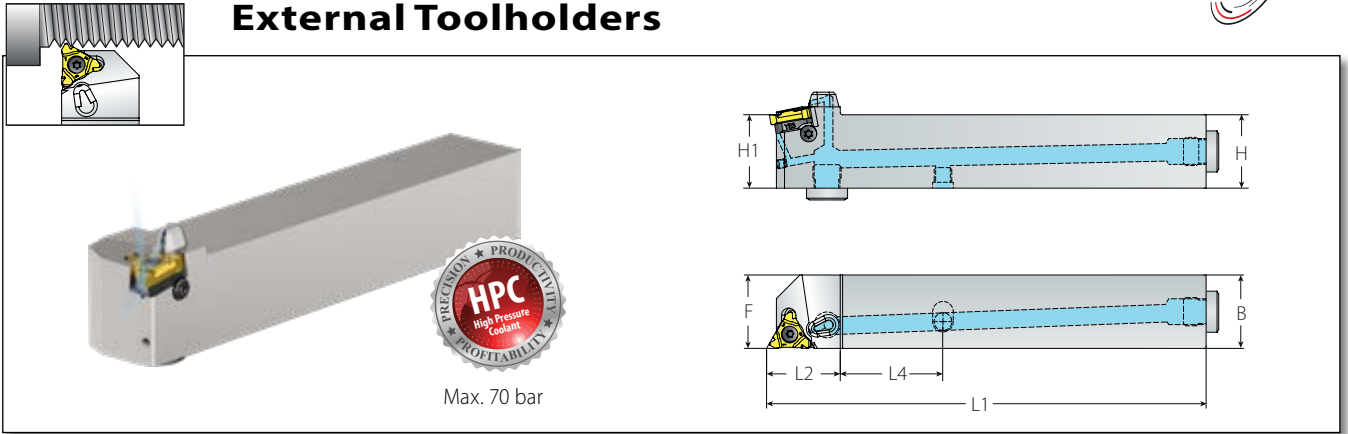

### MACH TT with Coolant (HPC) - 3 Inlets

Insert Size	Ordering Code	Market Description	Dimensions mm				Spare Parts						
IC	RH		H=H1=B	F	L1	L2	L4	Insert Screw	Anvil Screw	Torx Key	Anvil RH	Plug Screw x 2	Socket Screw
3/8"	ALCN16-3DT	ALCN16-16DT	16	16	100		25	SA3T (2.0 Nm)	SY3T	K3T	YE3	Plug G1/8"	Socket Screw M6x5
	ALCN20-3DT	ALCN20-16DT	20	20	125	25.4	30						
	ALCN25-3DT	ALCN25-16DT	25	25	150		35						
	ALCN32-3DT	ALCN32-16DT	32	32	170		35						

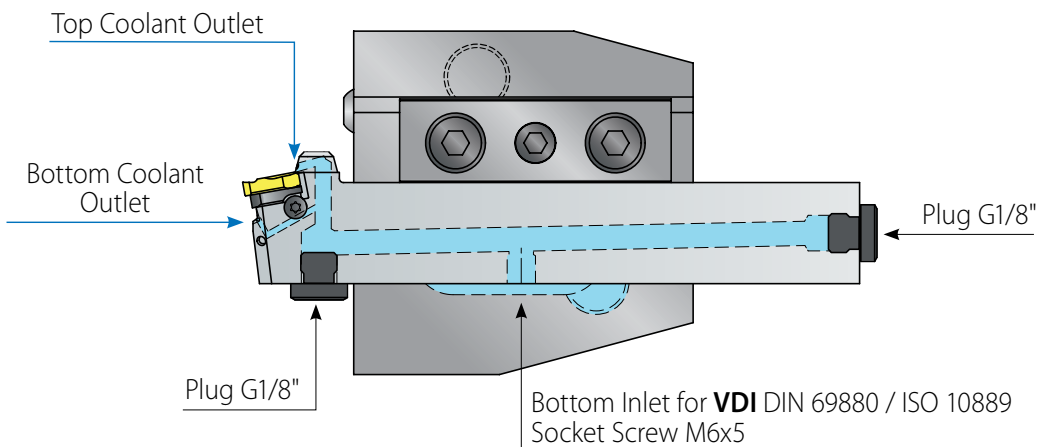

When reassembling the M6X5 plug, it is necessary to use LOCTITE 542.

The following HPC accessories (not included) can be ordered separately:

Image	Ordering Code	Item Number
	Tube Connector 25-6	013-00941
	Angled Fitting G1_8x6	013-00947
	Straight Fitting G1_8x6	013-00942

## External Toolholders

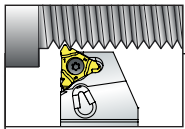

Max. 70 bar

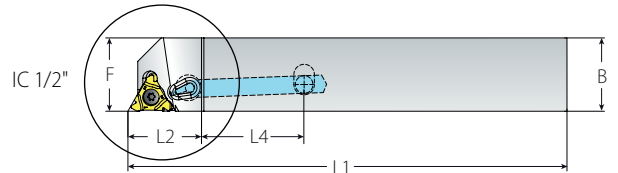
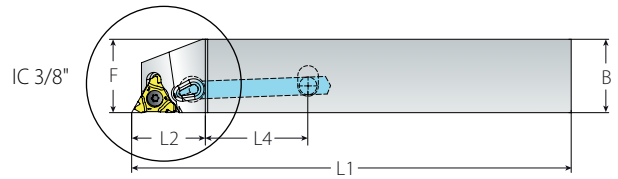
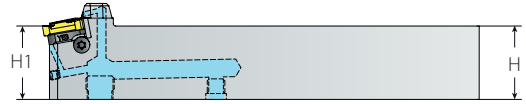

### MACH TT with Coolant (HPC) - 2 Inlets

#### Spare Parts

Insert Size	Ordering Code	Market Description	Dimensions mm										
IC	RH		H=H1=B	F	L1	L2	L4	Insert Screw	Anvil Screw	Torx Key	Anvil RH	Plug Screw	Socket Screw
3/8"	ALC16-3DT	ALC16-16DT	16	16	100		24.0	SA3T (2.0Nm)	SY3T	K3T	YE3	Flush Plug G1/8"	Socket Screw M6x5
	ALC20-3DT	ALC20-16DT	20	20	125	25.4	21.0						
	ALC25-3DT	ALC25-16DT	25	25	150		32.5						
	ALC32-3DT	ALC32-16DT	32	32	170		30.0						
1/2"	ALC25-4DT	ALC25-22DT	25	25	150		32.5	SA4T (3.0 Nm)	SY4T	K4T	YE4	Flush Plug G1/8"	Socket Screw M6x5
	ALC32-4DT	ALC32-22DT	32	32	170	27.5	30.0						
	ALC40-4DT	ALC40-22DT	40	40	206		35.0						

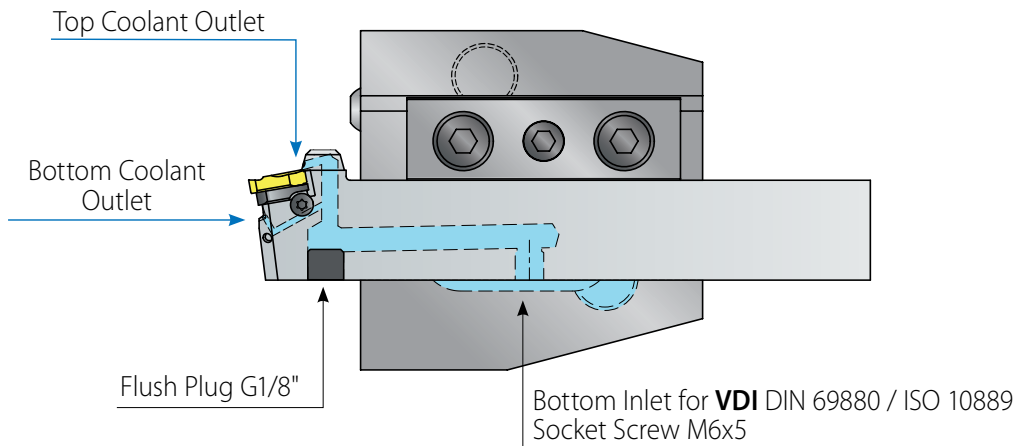

When reassembling the M6X5 plug, it is necessary to use LOCTITE 542.

The following HPC accessories (not included) can be ordered separately:

Image	Ordering Code	Item Number
	Tube Connector 25-6	013-00941
	Angled Fitting G1_8x6	013-00947
	Straight Fitting G1_8x6	013-00942

## External Toolholders

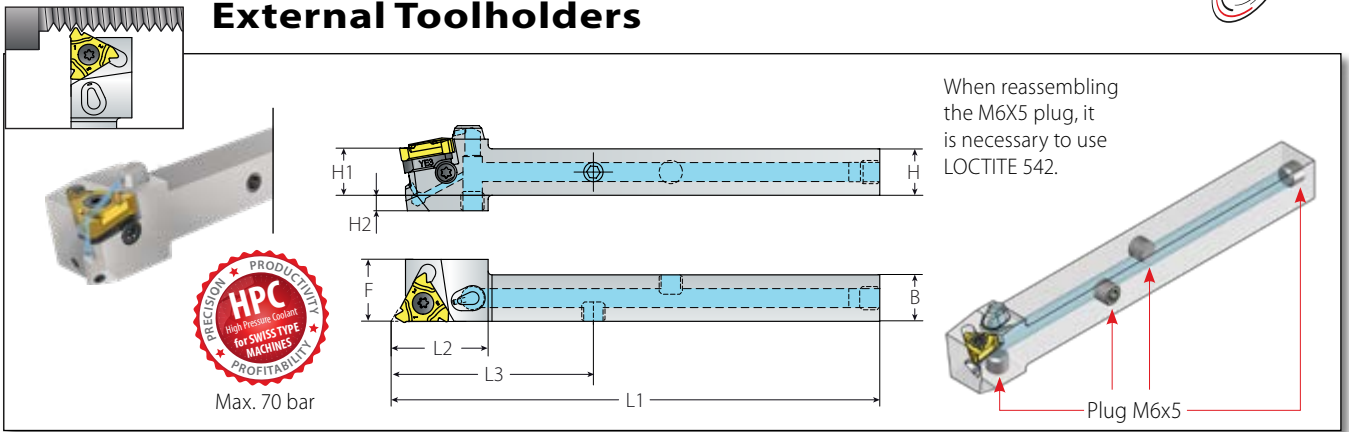

### MACH TT with Coolant for Swiss Type Machines (HPC)

#### Spare Parts

Insert Size	Ordering Code	Market Description	Dimensions mm										
IC	RH		H=H1=B	F	L1	L2	L3	H2	Insert Screw	Anvil Screw	Torx Key	Anvil RH	Plug x 4
3/8"	ALCS12-3DT	ALCS12-16DT	12	16	126.5	25.4	52.5	4	SA3T (2.0 Nm)	SY3T	K3T	YE3	Plug M6x5

When working with Shank 12x12 the extender is necessary to connect the fitting.

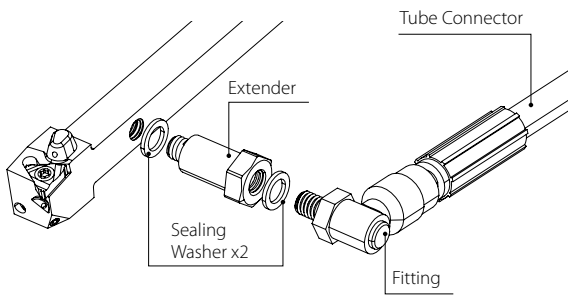

HPC accessories (not included) can be ordered separately:

Image	Ordering Code	Item Number
	Tube Connector 25-6	013-00941
	Angled Fitting M6x6	013-01011
	Straight Fitting M6x6	013-01012
	Extender M6x5	013-01096
	Sealing Washer M6	013-01097

## External Toolholders with Round Shanks

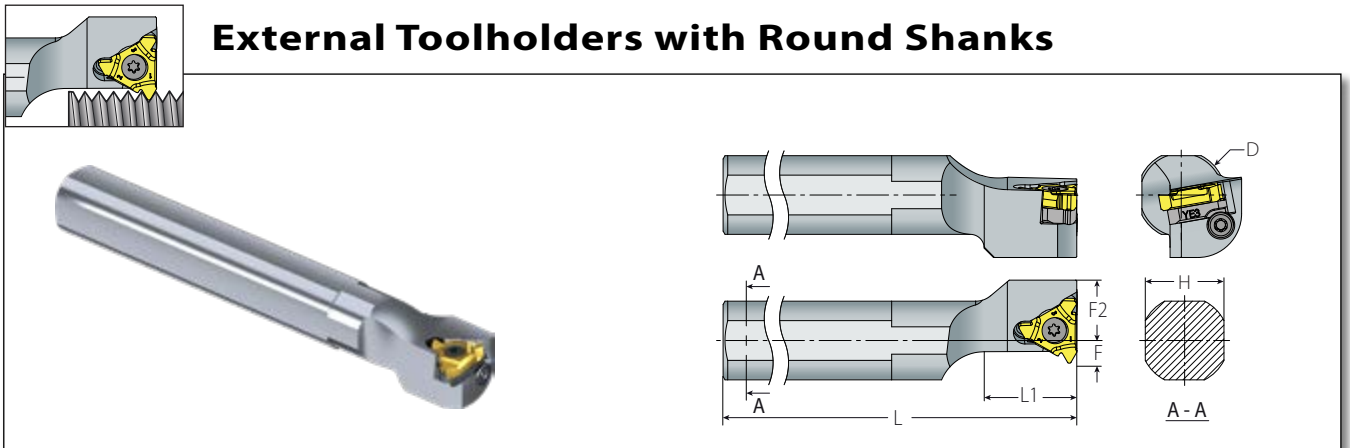

### MACH TT Toolholders for Swiss Type Machines

#### Spare Parts

Insert Size	Ordering Code	Market Description	Dimensions mm									
IC	RH		H	L	L1	D	F	F2	Insert Screw	Anvil Screw	Torx Key	Anvil RH
3/8"	ALVR075-3DT-LH	ALVR075-16DT-LH	17	140	20	.75 (inch)	6	13.5	SA3T	SY3T	K3T	YE3
	ALVR100-3DT-LH	ALVR100-16DT-LH	23			1.0 (inch)	10	16.0				
	ALVR20-3DT-LH	ALVR20-16DT-LH	18			20 (mm)	6	13.5				
	ALVR22-3DT-LH	ALVR22-16DT-LH	20			22 (mm)	6	13.5				
	ALVR25-3DT-LH	ALVR25-16DT-LH	23			25 (mm)	10	16.0				

## External Toolholders

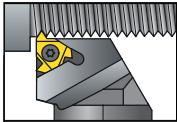

Max. 70 bar

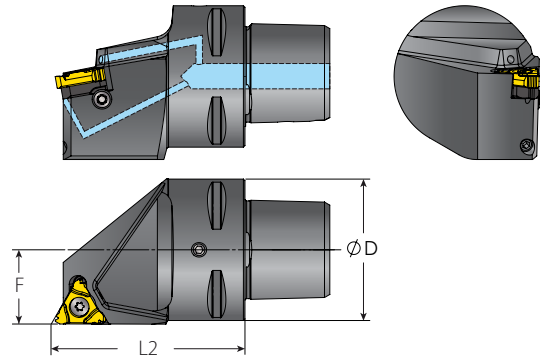

### MACH TT V-CAP with Coolant (HPC)

Insert Size	Ordering Code	Market Description	Dimensions mm			Spare Parts			
			D	F	L2	Insert Screw	Anvil Screw	Torx Key	Anvil RH
3/8"	VCAP32-SER17047-3DT	VCAP32-SER17047-16DT	32	17	47	SA3T (2.0 Nm)	SY3T	K3T	YE3
	VCAP40-SER21055-3DT	VCAP40-SER21055-16DT	40	21	55				
	VCAP50-SER26065-3DT	VCAP50-SER26065-16DT	50	26	65				
	VCAP63-SER33075-3DT	VCAP63-SER33075-16DT	63	33	75				
1/2"	VCAP40-SER21055-4DT	VCAP40-SER21055-22DT	40	21	55	SA4T (3.0Nm)	SY4T	K4T	YE4
	VCAP50-SER26065-4DT	VCAP50-SER26065-22DT	50	26	65				
	VCAP63-SER33075-4DT	VCAP63-SER33075-22DT	63	33	75				
	VCAP80-SER42080-4DT	VCAP80-SER42080-22DT	80	42	80				

## External Toolholders

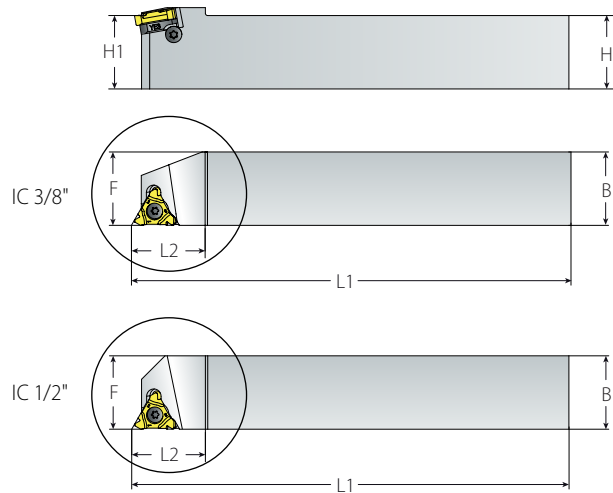
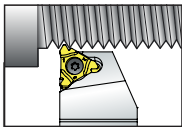

### MACH TT

Insert Size	Ordering Code	Market Description	Dimensions mm				Spare Parts			
			H=H1=B	F	L1	L2	Insert Screw	Anvil Screw	Torx Key	Anvil RH
3/8"	AL12-3DT	AL12-16DT	12	16	85	20.7	SA3T (2.0 Nm)	SY3T	K3T	YE3
	AL16-3DT	AL16-16DT	16	16	100	22.0				
	AL20-3DT	AL20-16DT	20	20	127	24.5				
	AL25-3DT	AL25-16DT	25	25	150	25.8				
1/2"	AL32-3DT	AL32-16DT	32	32	170	29.5	SA4T (3.0Nm)	SY4T	K4T	YE4
	AL25-4DT	AL25-22DT	25	25	150	27.5				
	AL40-4DT	AL40-22DT	40	40	198	27.5				



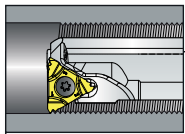

## Internal Toolholders

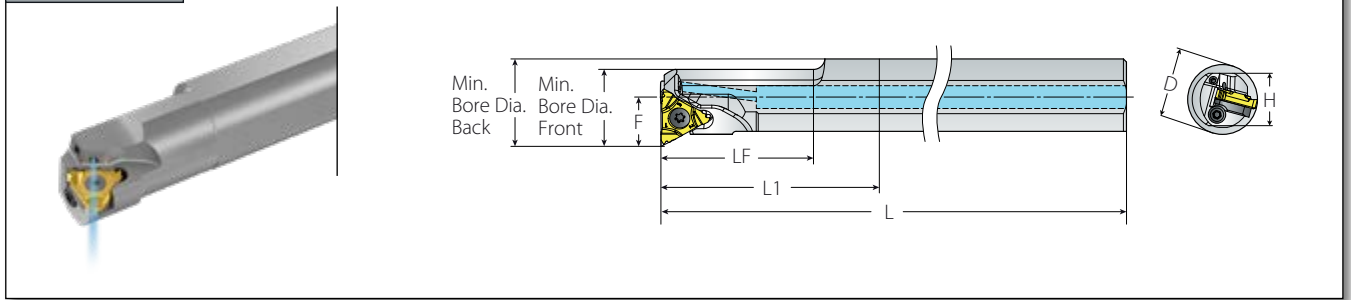

### MACH TT with Coolant (HPC)

#### Spare Parts

Insert Size	Ordering Code	Market Description	Dimensions mm								Spare Parts			
			H	L	LF	L1	D	F	Minimum Bore Ø Front	Minimum Bore Ø Back	Insert Screw*	Anvil Screw	Insert Key	Anvil
3/8"	NVRC-1617-3DT	NVRC-1617-16DT	15	150	27	48	16	11.7	17	20.0	SN3T	-	-	-
	NVRC-2020-3DT	NVRC-2020-16DT	18	180	40	60	20	13.7	20	24.1	-	-	-	-
	AVRC-2022-3DT	AVRC-2022-16DT	18	180	40	60	20	13.7	22	24.0	SA3T	SY3T	-	Y13
	NVRC-2022-3DT	NVRC-2022-16DT	18	180	40	60	20	13.7	22	24.0	SN3T	-	K3T	-
	AVRC-2526-3DT	AVRC-2526-16DT	23	200	40	75	25	16.1	26	29.0	-	-	-	-
	AVRC-3229-3DT	AVRC-3229-16DT	29	250	40	96	32	19.7	29	36.5	-	-	-	-
	AVRC-3236-3DT	AVRC-3236-16DT	29	250	40	96	32	19.7	36	36.0	SA3T	SY3T	-	Y13
	AVRC-4037-3DT	AVRC-4037-16DT	36	300	40	120	40	23.6	37	44.0	-	-	-	-

\* All insert screws max. torque 2.0 Nm

## New Ordering Code System for MACH TT Internal Holders

The numbers in the ordering code represent the shank diameter (D) and Minimum Bore Ø Front.

Minimum Bore Ø Front = 22 mm

For example: AVRC - 20 22 -3DT

D = 20 mm

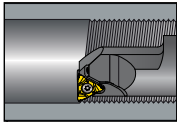

## Internal Toolholders

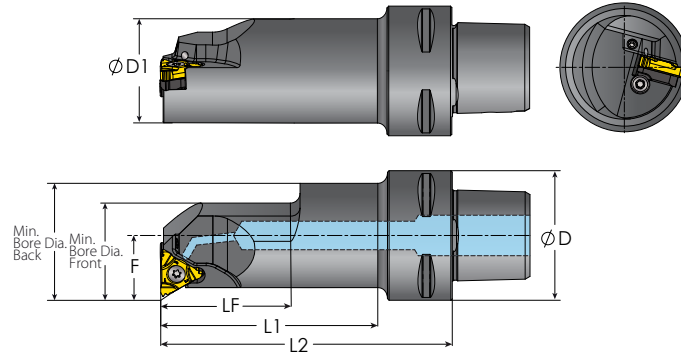

### MACH TT V-CAP with Coolant (HPC)

Insert Size	Ordering Code	Market Description	Dimensions mm								Spare Parts			
			D	D1	F	L2	LF	L1	Minimum Bore Ø Front	Minimum Bore Ø Back	Insert Screw*	Anvil Screw	Insert Key	Anvil
3/8"	VCAP32-SIR12055-3DT	VCAP32-SIR12055-16DT	32	16.2	12	55	27	37	18.5	20.5	SN3T	-	-	-
	VCAP40-SIR10060-3DT	VCAP40-SIR10060-16DT	40	12.9	10.3	60	27	37	-	17.0	SN3TM	-	-	-
	VCAP40-SIR12060-3DT	VCAP40-SIR12060-16DT		16.2	12	60	27	37	18.5	20.5	SN3T	-	-	-
	VCAP40-SIR14060-3DT	VCAP40-SIR14060-16DT		20.6	14	60	27	37	23	25.0	SA3T	SY3T	Y13	-
	VCAP40-SIR17070-3DT	VCAP40-SIR17070-16DT		26.2	17	70	32	47	27.5	31.0				
	VCAP40-SIR20090-3DT	VCAP40-SIR20090-16DT	32.2	20	90	40	67	33	36.5	SN3T	-	K3T	-	
	VCAP40-SIR24080-3DT	VCAP40-SIR24080-16DT	40.2	24	80	45	60	40	44.5					
	VCAP50-SIR12060-3DT	VCAP50-SIR12060-16DT	50	16.2	12	60	27	37	18.5	20.5	SA3T	SY3T	Y13	-
	VCAP50-SIR14060-3DT	VCAP50-SIR14060-16DT		20.6	14	60	27	37	23	25.0				
	VCAP50-SIR17070-3DT	VCAP50-SIR17070-16DT		26.2	17	70	32	47	27.5	30.5	SA3T	SY3T	Y13	-
	VCAP50-SIR20090-3DT	VCAP50-SIR20090-16DT		32.2	20	90	40	67	33	36.5				
	VCAP50-SIR24105-3DT	VCAP50-SIR24105-16DT	40.2	24	105	45	82	40	44.5	63	SA3T	SY3T	Y13	-
	VCAP63-SIR14070-3DT	VCAP63-SIR14070-16DT	20.5	14	70	27	45	23	25.0					
	VCAP63-SIR17075-3DT	VCAP63-SIR17075-16DT	26.2	17	75	32	50	27.5	31.0					
VCAP63-SIR20090-3DT	VCAP63-SIR20090-16DT	32.2	20	90	40	65	33	36.5						
VCAP63-SIR24105-3DT	VCAP63-SIR24105-16DT	40.2	24	105	45	80	40	44.5						

\* All insert screws max. torque 2.0 Nm

# Internal Toolholders

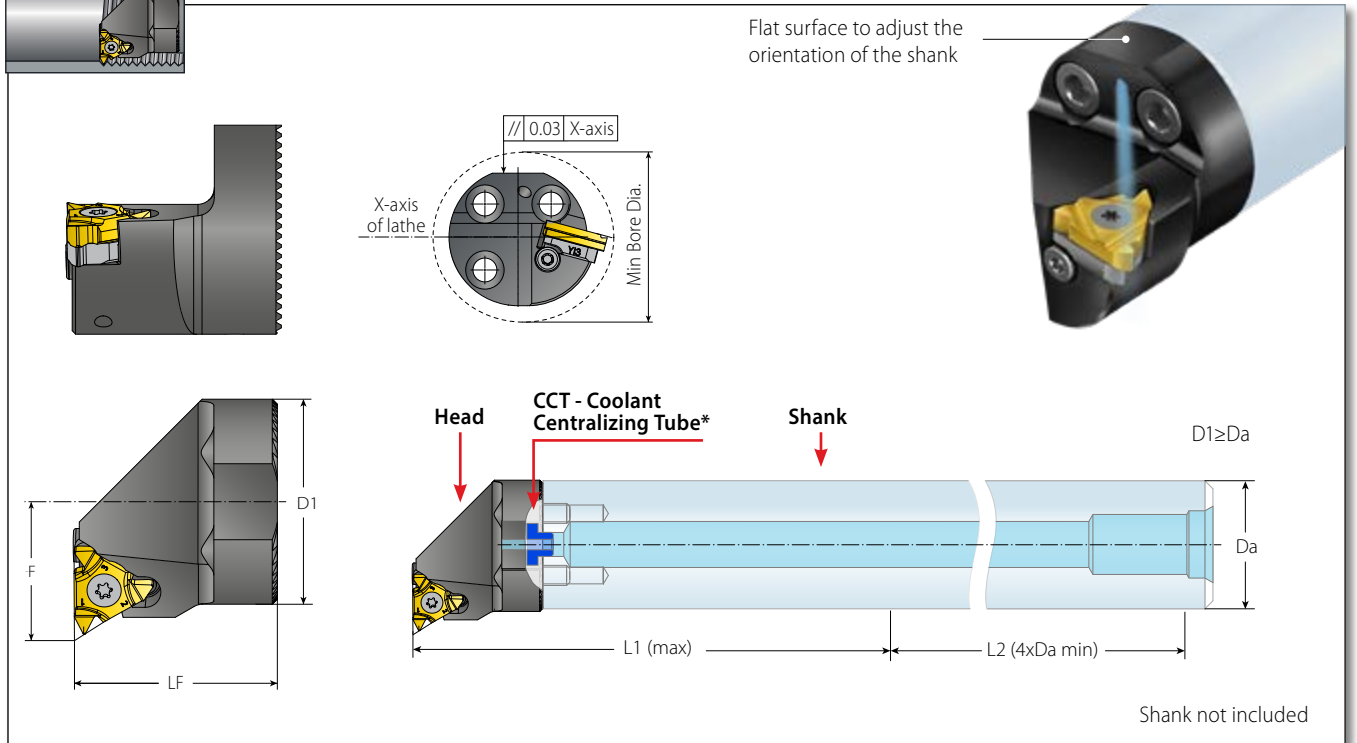

## MACH TT Smooth Cut System

### Spare Parts

Insert Size	Ordering Code	Market Description	Dimensions mm						Spare Parts				
IC	RH		D1	Da	F	L1	LF	Min. Bore Dia.	Insert Screw	Anvil Screw	Insert Key	Anvil	CCT - Coolant Centralizing Tube*
				mm inch		max							
3/8"	VAS32-IR3222-3DT	VAS32-IR3222-16DT	32.3	32 1.25"	22	160	32.25	40	SA3T (2.0 Nm)	SY3T	K3T	Y13	CCT12
	VAS40-IR3227-3DT	VAS40-IR3227-16DT	40	40 1.50"	27	200	32.25	50					

\* When assembling the CCT, it is recommended to use LOCTITE 648

## Recommended Cutting Speeds Vc [m/min] for MACH TT

Material Group	Vargus No.	Material	Hardness Brinell HB	Vc [m/min]	
				VK8	
<b>P</b> Steel	1	Unalloyed Steel	Low Carbon (C=0.1-0.25%)	125	115-175
	2		Medium Carbon (C=0.25-0.55%)	150	100-165
	3		High Carbon (C=0.55-0.85%)	170	90-155
	4	Low Alloy Steel (alloying elements ≤ 5%)	Non Hardened	180	100-165
	5		Hardened	275	75-130
	6		Hardened	350	70-125
	7	High Alloy Steel (alloying elements > 5%)	Annealed	200	80-110
	8		Hardened	325	50-95
	9	Cast Steel	Low Alloy (alloying elements < 5%)	200	70-120
	10		High Alloy (alloying elements > 5%)	225	60-110
<b>M</b> Stainless Steel	11	Stainless Steel Ferritic	Non Hardened	200	70-120
	12		Hardened	330	60-105
	13	Stainless Steel Austenitic	Austenitic	180	90-130
	14		Super Austenitic	200	40-100
	15	Stainless Steel Cast Ferritic	Non Hardened	200	90-110
	16		Hardened	330	65-100
	17	Stainless Steel Cast Austenitic	Austenitic	200	85-100
	18		Hardened	330	60-100
<b>K</b> Cast Iron	28	Malleable Cast Iron	Ferritic (short chips)	130	60-70
	29		Pearlitic (long chips)	230	60-135
	30	Grey Cast Iron	Low Tensile Strength	180	70-120
	31		High Tensile Strength	260	60-105
	32	Nodular Sg Iron	Ferritic	160	125-145
	33		Pearlitic	260	90-110
<b>N</b> Non-Ferrous Metals	34	Aluminum Alloys Wrought	Non Aging	60	100-325
	35		Aged	100	80-205
	36	Aluminum Alloys	Cast	75	200-370
	37		Cast & Aged	90	200-260
	38	Aluminum Alloys	Cast Si 13-22%	130	60-165
	39	Copper and Copper Alloys	Brass	90	80-210
	40		Bronze And Non Leaded Copper	100	80-235
	<b>S</b> Heat Resistant Material	19	High Temperature Alloys	Annealed (iron based)	200
20		Aged (iron based)		280	30-50
21		Annealed (nickel or cobalt based)		250	20-30
22		Aged (nickel or cobalt based)		350	15-25
23		Titanium Alloys	Pure 99.5 Ti	400Rm	140-160
24			α+β Alloys	1050Rm	50-70
<b>H</b> Hardened Material	25	Extra Hard Steel	Hardened & Tempered	45-50HRC	45-60
	26			51-55HRC	40-50

Grade	Application	Sample
<b>VK8</b>	High wear resistance for general purpose applications. AlTiN+TiN PVD Coating	

## Number of Passes for MACH TT

Pitch	mm	0.70	0.75	1.00	1.25	1.50	1.75	2.00	2.50	3.00	3.50	4.00	4.50	5.00	5.50	6.00
	TPI	36	32	24	20	16	14	12	10	8	7	6	5.5	5	4.5	4
<b>No. of passes - MACH TT*</b>		<b>2-4</b>	<b>2-4</b>	<b>2-4</b>	<b>3-4</b>	<b>3-4</b>	<b>4-6</b>	<b>4-6</b>	<b>5-7</b>	<b>5-7</b>	<b>6-8</b>	<b>6-8</b>	<b>7-9</b>	<b>8-10</b>	<b>9-12</b>	<b>11-14</b>
<i>In comparison (for your reference): No. of passes for Standard tools</i>		(4-7)	(4-7)	(4-8)	(5-9)	(6-10)	(7-12)	(7-12)	(8-14)	(9-16)	(10-18)	(11-18)	(11-19)	(12-20)	(12-20)	(12-20)

\* For internal threading an additional pass is required.

## Infeed Methods and Type of Passes

### MACH TT 3/8" EX & IN Tools - Flank Infeed method

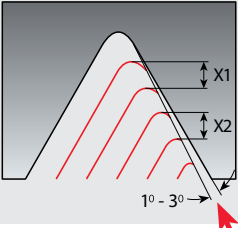

1. Use the flank infeed method (modified) with 1° - 3°.
2. Use the constant depth type of passes. X1 = X2

### MACH TT 1/2" EX Tools - Radial Infeed method

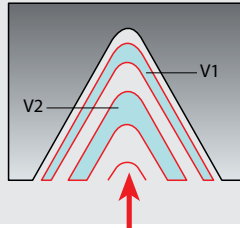

1. Use the Radial Infeed method.
2. Use the constant volume type of passes. V1 = V2

## Thread Turning Methods for Symmetrical Inserts

Thread	Inserts & Toolholder	Rotation	Feed Direction	Helix Method	Drawing
Right Hand External	EX RH	Counterclockwise	Towards chuck	Regular	1
Left Hand External	EX RH	Counterclockwise	From chuck	Reversed	6
Right Hand Internal	IN RH	Counterclockwise	Towards chuck	Regular	3
Left Hand Internal	IN RH	Clockwise	From chuck	Reversed	8

MACH TT tools are designed for Right Hand applications, but can also be used for Left Hand threads.

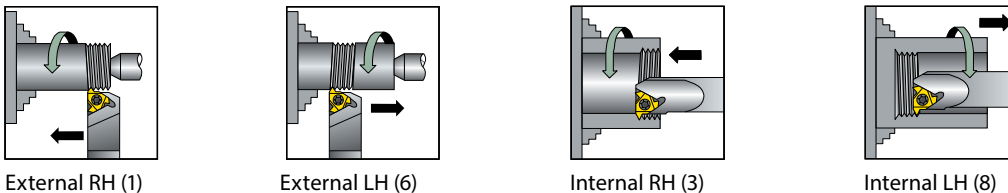





## Anvils

Resultant Helix Angle		2.5°	1.5°	0.5°		
Insert Size	Holder	Ordering Code				
IC	L mm					
	3/8"	16	ER	YE3-1P	<b>YE3</b>	YE3-1N
	1/2"	22	ER	YE4-1P	<b>YE4</b>	YE4-1N
	3/8"	16	IR	YI3-1P	<b>YI3</b>	YI3-1N

## Insert & Toolholder Combinations

- MACH toolholders are suitable with MACH inserts only
- Standard toolholders can be used with MACH inserts **but is less recommended**

	MACH TT Insert	Standard Insert
<b>MACH TT Holder</b>	✓✓✓ 	✗ 
<b>Standard Holder</b>	✓✓ 	✓ 

## Features and Innovations

### Improved Profile Design

Superior threading surface finish



### Improved Rake & Reinforced Geometry

For high resistance with a reduced number of passes

### Versatile System

One holder can use either single-sided or double-sided inserts

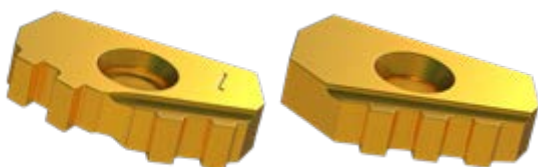

25D  
(double-sided)

25S  
(single-sided)



# UNMATCHED PRODUCTIVITY

## Advanced Surface Treatment

Reinforced cutting edge and smooth surface finish



## Advantages



Decreased  
Number of  
Passes



Reduced  
Machining  
Time



Longer  
Tool Life

## VK8 Grade

High wear resistance for general purpose applications  
AlTiN + TiN PVD coating

## Vargus Dovetail Clamping System

Super rigid - designed for high loads



## API Buttress Casing

### External

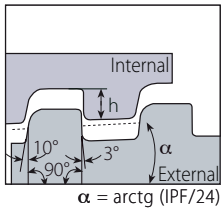

Defined by: STD.5B.1979  
Tolerance class: Standard API

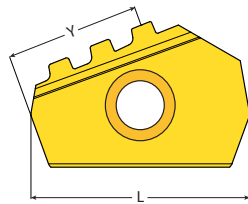

25S

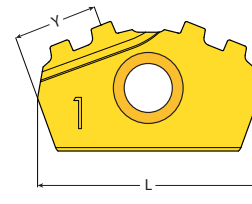

25D



### External



Insert Style	Insert Size	Pitch	Teeth	Ordering Code	Size	Dimensions mm			Anvil		
						L mm	TPI	IPF	RH	Toolholder	
25S	25	5	0.75	3	25SER5BUT75-3TH...	4 1/2" - 13 3/8"	1.55	15.2	5	YE25M	ALC...-25DT
		5	1	3	25SER5BUT1-3TH...	16" - 20"	1.55	15.2			
25D	25	5	0.75	2	25DER5BUT75-2TH...	4 1/2" - 13 3/8"	1.55	9.5	5	YE25M	ALC...-25DT
		5	1	2	25DER5BUT1-2TH...	16" - 20"	1.55	9.7			

## API Buttress Casing

### Internal

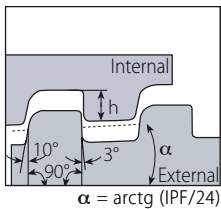

Defined by: STD.5B.1979  
Tolerance class: Standard API

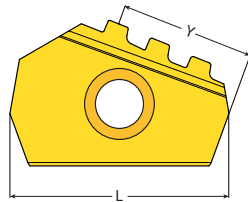

25S

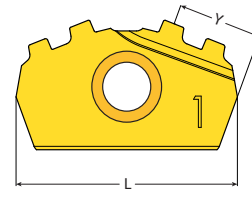

25D



### Internal



Insert Style	Insert Size	Pitch	Teeth	Ordering Code	Size	Dimensions mm			Anvil		
						L mm	TPI	IPF	RH	Toolholder	
25S	25	5	0.75	3	25SIR5BUT75-3TH...	4 1/2" - 13 3/8"	1.55	15.2	5	YI25M	AVRC...-25DT
		5	1	3	25SIR5BUT1-3TH...	16" - 20"	1.55	15.8			
25D	25	5	0.75	2	25DIR5BUT75-2TH...	4 1/2" - 13 3/8"	1.55	9.9	5	YI25M	AVRC...-25DT
		5	1	2	25DIR5BUT1-2TH...	16" - 20"	1.55	9.7			



## API Round Casing & Tubing

**External**

Defined by: API SPEC. 5B  
Tolerance class: Standard API RD

25S 25D

### External

Insert Style	Insert Size	Pitch	Teeth	Ordering Code	Dimensions mm			Anvil	
					L mm	TPI	RH	h min	Y
25S	25	10	4	25SER10APIRD-4TH...	1.41	11	5	YE25M	ALC..-25DT
		10	6	25SER10APIRD-6TH...	1.41	16.7			
		8	5	25SER8APIRD-5TH...	1.81	16.8			
25D	25	10	3	25DER10APIRD-3TH...	1.41	8.5	5	YE25M	ALC..-25DT
		10	4	25DER10APIRD-4TH...	1.41	11.0			
		8	3	25DER8APIRD-3TH...	1.81	10.0			

## API Round Casing & Tubing

**Internal**

Defined by: API SPEC. 5B  
Tolerance class: Standard API RD

25S 25D

### Internal

Insert Style	Insert Size	Pitch	Teeth	Ordering Code	Dimensions mm			Anvil	
					L mm	TPI	RH	h min	Y
25S	25	10	6	25SIR10APIRD-6TH...	1.41	16.5	5	YI25M	AVRC..-25DT
		10	4	25SIR10APIRD-4TH...	1.41	11.0			
		8	5	25SIR8APIRD-5TH...	1.81	16.2			
25D	25	10	4	25DIR8APIRD-4TH...	1.81	13.5	5	YI25M	AVRC..-25DT
		10	4	25DIR10APIRD-4TH...	1.41	11.0			
		10	3	25DIR10APIRD-3TH...	1.41	8.5			
		8	3	25DIR8APIRD-3TH...	1.81	8.5			

## GOST (OTTM / OTTG)

### External

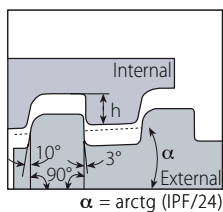

Defined by: Standard  
Tolerance class: 632-80

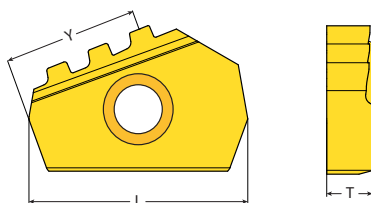

25S

### External



Insert Style	Insert Size	Pitch	Teeth	Ordering Code	Dimensions mm			Anvil		
					L mm	TPI	IPF	RH	h min	Y
25S	25	5	3	0.75	25SER5OTTM-3TH...	1.6	15.7	5	YE25M	ALC.-25DT

## GOST (OTTM / OTTG)

### Internal

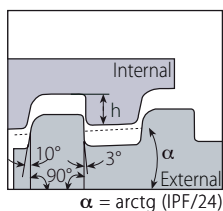

Defined by: Standard  
Tolerance class: 632-80

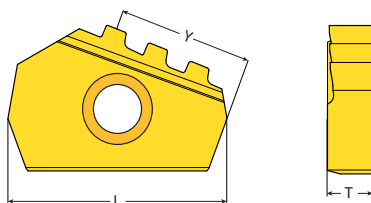

25S

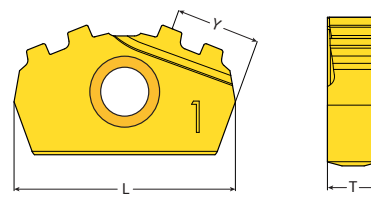

25D

### Internal



Insert Style	Insert Size	Pitch	Teeth	Ordering Code	Dimensions mm			Anvil	
					L mm	TPI	IPF	RH	h min
25S	25	5	3	25SIR5OTTM-3TH...	1.6	14.3	5	YI25M	ALC.-25DT
25D			2	25DIR5OTTM-2TH...	1.6	9.5			

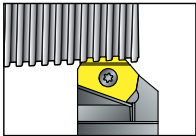

## External Toolholders

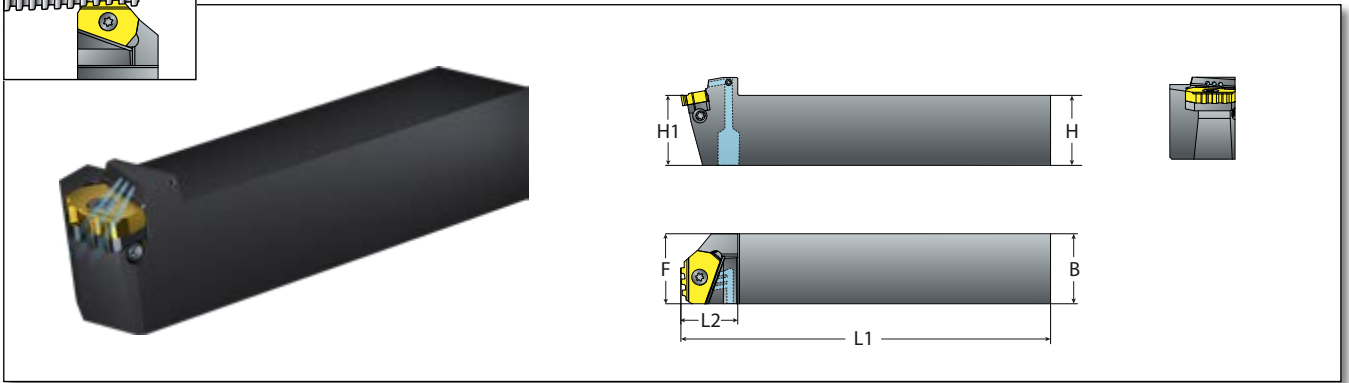

### MACH 25\* with Coolant

Insert Size	Ordering Code		Dimensions mm				Spare Parts			
	RH	H=H1=B	F	L1	L2	Insert Screw	Anvil Screw	Torx Key	Anvil RH	
25	ALC25-25DT	25	30	150	26	SA4T	SY25TW	K6T	YE25M	
	ALC32-25DT	32	32	170						
	ALC40-25DT	40	40	200						

\* All MACH 25 style toolholders have a 0° helix angle

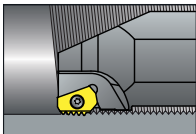

## Internal Toolholders

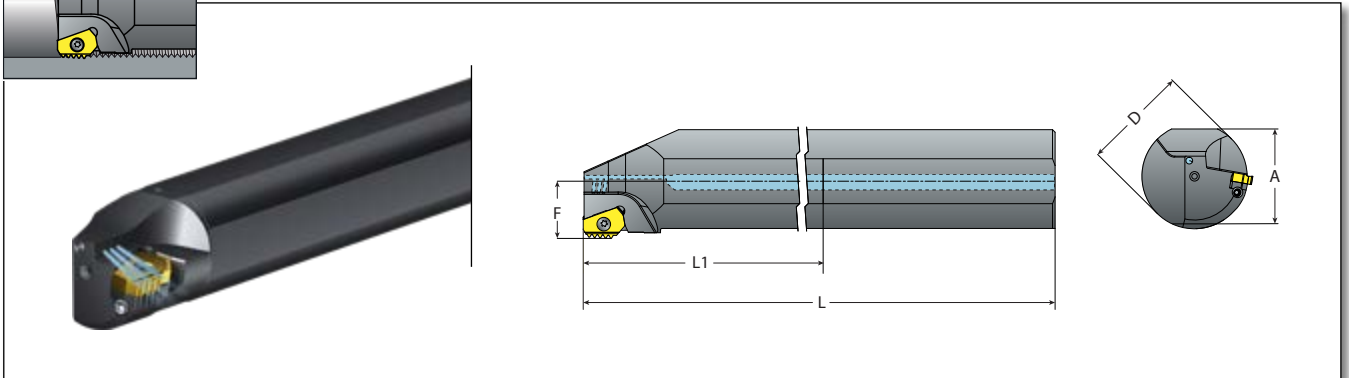

### MACH 25\* with Coolant

Insert Size	Ordering Code		Dimensions mm					Spare Parts			
	RH	A	L	L1 max	D	F	Minimum Bore Ø	Insert Screw	Anvil Screw	Torx Key	Anvil
25	AVRC40-25DT	36	300	160	40	23.3	60	SA4T	SY25TW	K6T	YI25M
	AVRC50-25DT	45	350	200	50	28.3	70				
	AVRC60-25DT	54	400	240	60	33.3	80				

\* All MACH 25 style toolholders have a 0° helix angle

## Recommended Cutting Speeds Vc [m/min] for MACH 25

Material Group	Vargus No.	Material	Hardness Brinell HB	Vc [m/min]	
				VK8	
<b>P</b> Steel	1	Unalloyed Steel	Low Carbon (C=0.1-0.25%)	125	115-175
	2		Medium Carbon (C=0.25-0.55%)	150	100-165
	3		High Carbon (C=0.55-0.85%)	170	90-155
	4	Low Alloy Steel (alloying elements ≤5%)	Non Hardened	180	100-165
	5		Hardened	275	75-130
	6		Hardened	350	70-125
	7	High Alloy Steel (alloying elements >5%)	Annealed	200	80-110
	8		Hardened	325	50-95
	9	Cast Steel	Low Alloy (alloying elements <5%)	200	70-120
	10		High Alloy (alloying elements >5%)	225	60-110
<b>M</b> Stainless Steel	11	Stainless Steel Ferritic	Non Hardened	200	70-120
	12		Hardened	330	60-105
	13	Stainless Steel Austenitic	Austenitic	180	90-130
	14		Super Austenitic	200	40-100
	15	Stainless Steel Cast Ferritic	Non Hardened	200	90-110
	16		Hardened	330	65-100
	17	Stainless Steel Cast Austenitic	Austenitic	200	85-100
	18		Hardened	330	60-100
<b>K</b> Cast Iron	28	Malleable Cast Iron	Ferritic (short chips)	130	60-70
	29		Pearlitic (long chips)	230	60-135
	30	Grey Cast Iron	Low Tensile Strength	180	70-120
	31		High Tensile Strength	260	60-105
	32	Nodular Sg Iron	Ferritic	160	125-145
	33		Pearlitic	260	90-110
<b>N</b> Non-Ferrous Metals	34	Aluminum Alloys Wrought	Non Aging	60	100-325
	35		Aged	100	80-205
	36	Aluminum Alloys	Cast	75	200-370
	37		Cast & Aged	90	200-260
	38	Aluminum Alloys	Cast Si 13-22%	130	60-165
	39	Copper and Copper Alloys	Brass	90	80-210
	40		Bronze And Non Leaded Copper	100	80-235
<b>S</b> Heat Resistant Material	19	High Temperature Alloys	Annealed (iron based)	200	45-60
	20		Aged (iron based)	280	30-50
	21		Annealed (nickel or cobalt based)	250	20-30
	22		Aged (nickel or cobalt based)	350	15-25
	23	Titanium Alloys	Pure 99.5 Ti	400Rm	140-160
	24		α+β Alloys	1050Rm	50-70
<b>H</b> Hardened Material	25	Extra Hard Steel	Hardened & Tempered	45-50HRC	45-60
	26			51-55HRC	40-50

Grade	Application	Sample
<b>VK8</b>	High wear resistance for general purpose applications. AlTiN+TiN PVD Coating	

## Cutting Pass Division Recommendations for Multi Tooth Inserts

The following table provides the optimal cutting pass division options, depending on the material, machine stability and clamping conditions:

Application	No. of Passes/ Pass No.	1	2	3	4	5	6
APIRD 8 Ex, In	3 passes	0.89	0.81	0.11			
	4 passes	0.60	0.58	0.52	0.11		
	5 passes	0.47	0.47	0.43	0.33	0.11	
	6 passes	0.39	0.41	0.37	0.29	0.24	0.11
APIRD 10 Ex, In	3 passes	0.67	0.63	0.11			
	4 passes	0.44	0.45	0.41	0.11		
	5 passes	0.34	0.37	0.33	0.26	0.11	
	6 passes	0.28	0.32	0.29	0.22	0.19	0.11
BUT 5 Ex, In	3 passes	0.760	0.705	0.110			
	4 passes	0.506	0.501	0.458	0.110		
	5 passes	0.395	0.409	0.374	0.287	0.110	
	6 passes	0.329	0.353	0.324	0.249	0.210	0.110
OTTM 5 Ex, In OTTG 5 Ex, In	3 passes	0.760	0.730	0.110			
	4 passes	0.506	0.501	0.483	0.110		
	5 passes	0.395	0.409	0.374	0.312	0.110	
	6 passes	0.329	0.353	0.324	0.249	0.235	0.110

## Anvils

		Resultant Helix Angle 0°			
		Insert Size		Holder	Ordering Code
		IC	L mm		
	25S/25D	25	ER	YE25M	
	25S/25D	25	IR	YI25M	



## Features and Innovations

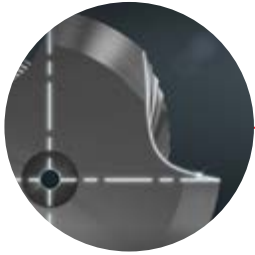

### Improved Cutting Edge & Reinforced Geometry

For high loads

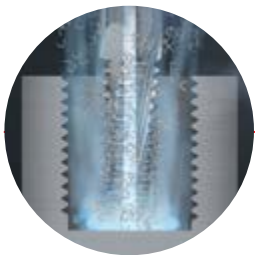

### Coolant Thru

For better chip flow and surface finish

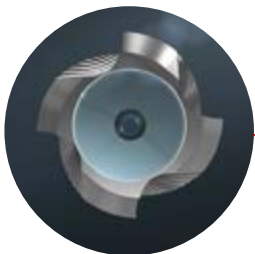

### Large Core Diameter

For increased stability



### Additional Flutes

For higher feed rate

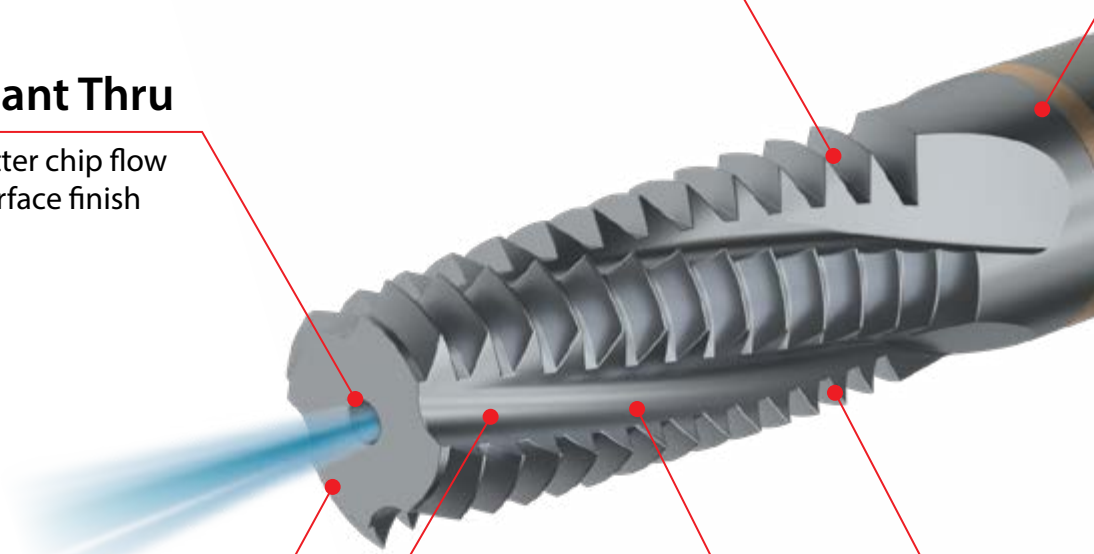



# UNMATCHED PRODUCTIVITY

## New Innovative VH4 Grade

High wear resistance for general purpose applications - TiCN PVD Coating

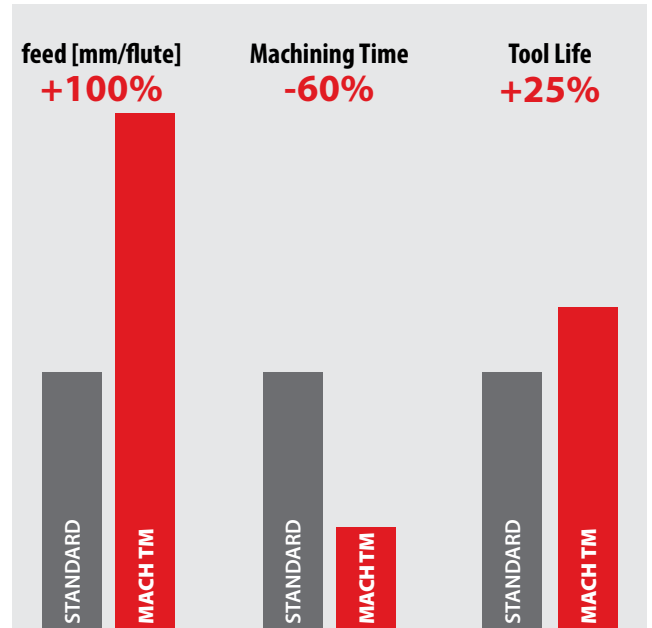
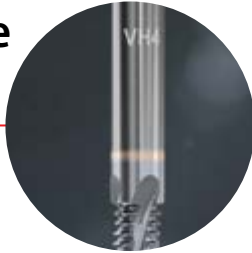

## Advantages

- ✓ High feed mm/flute
- ✓ Dramatically decreases machining time
- ✓ Extended tool life
- ✓ Excellent surface finish

## Advanced Surface Treatment

Reinforced cutting edge and improved surface finish

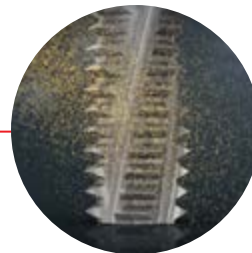

## Optimal Flute Length

For higher rigidity and efficient chip evacuation

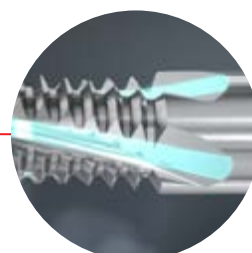

# ISO Metric

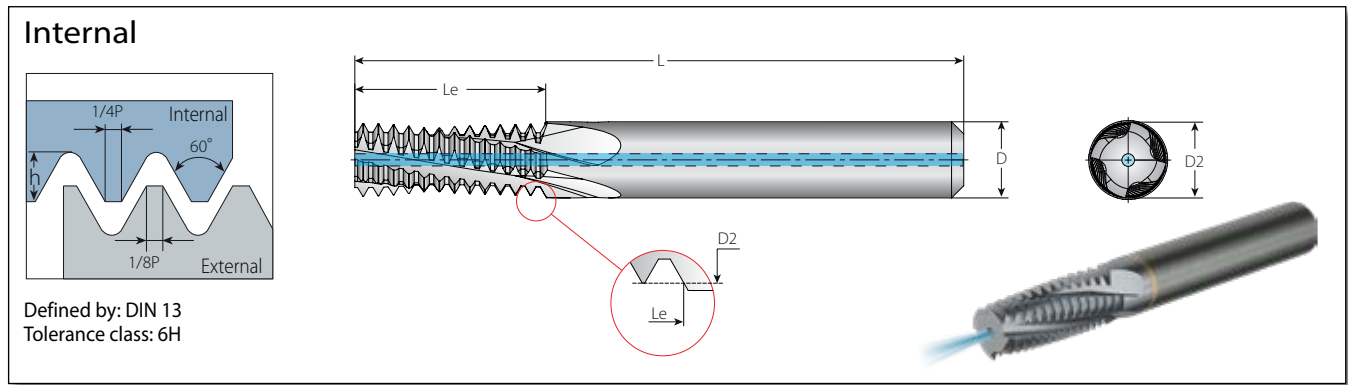

## Helical Flutes with Thru-Hole Coolant

2 x Do (Le ≤ 2 x Thread Diameter)

Thread		Pitch	Ordering Code	Dimensions mm			No. of Flutes	Teeth	Bore Dia.**	
M Coarse	M Fine	mm	Internal	D	D2	L	Le	Z	Zt	mm
M3x0.5	M3.5-M16x0.5	0.5	HCF03024L06-I0.50ISOTM4	3	2.4	28.0	6.2	4	12	2.5
	M4x0.5	0.5	HCF03029L08-I0.50ISOTM4...	3	2.9	28.0	8.2	4	16	3.5
M4x0.7		0.7	HCF03029L08-I0.70ISOTM4...	3	2.9	30.0	8.7	4	12	3.3
	M6x0.75	0.75	HCF05049L12-I0.75ISOTM4...	5	4.9	40.0	12.4	4	16	5.3
M5x0.8		0.8	HCF04039L10-I0.80ISOTM4...	4	3.9	35.0	10.8	4	13	4.2
M6x1.0	M8-M40x1.0	1.0	HCF05048L12-I1.00ISOTM4...	5	4.8	41.0	12.5	4	12	5.0
M8x1.25		1.25	HCF06059L16-I1.25ISOTM4...	6	5.9	61.0	16.9	4	13	6.8
M10x1.5	M12-M48x1.5	1.5	HCF08079L20-I1.50ISOTM4...	8	7.9	64.0	20.2	4	13	8.5
M12x1.75		1.75	HCF10099L25-I1.75ISOTM5...	10	9.9	73.0	25.4	5	14	10.2
M14x2.0	M17-M80x2.0	2.0	HCF12116L29-I2.00ISOTM5...	12	11.6	80.0	29.0	5	14	12.0
M16x2.0	M17-M80x2.0	2.0	HCF12119L33-I2.00ISOTM5...	12	11.9	92.0	33.0	5	16	14.0
M20x2.5		2.5	HCF16159L41-I2.50ISOTM5...	16	15.9	102.0	41.2	5	16	17.5

\*\* Bore diameter applies to smallest thread dia.



## American UN

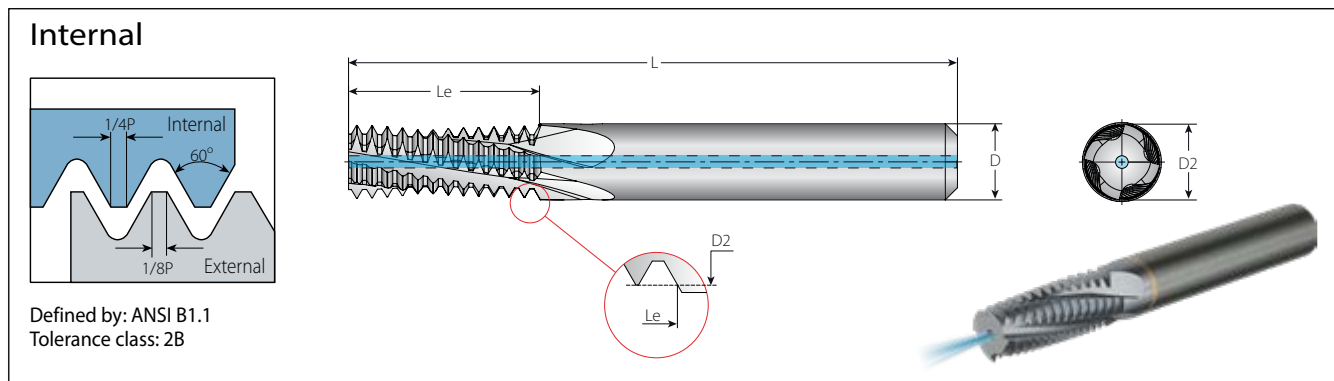

### Helical Flutes with Thru-Hole Coolant

2 x Do ( $Le \leq 2 \times \text{Thread Diameter}$ )

Thread			Pitch	Ordering Code	Dimensions mm			No. of Flutes	Teeth	Bore Dia.**	
UNC	UNF	UNEF	TPI	Internal	D	D2	L	Le	Z	Zt	mm
	1/4"x28	7/16"-1/2"x28	28	HCF05049L13-I28UNTM4...	5	4.90	40	13.1	4	14	5.5
	5/16"; 3/8"x24	9/16"-11/16"x24	24	HCF06059L16-I24UNTM4...	6	5.90	59	16.4	4	15	6.8
	3/8"x24	9/16"-11/16"x24	24	HCF08079L19-I24UNTM4...	8	7.90	62	19.6	4	18	8.5
1/4"-20	7/16"; 1/2"x20	3/4"-1"x20	20	HCF05049L13-I20UNTM4...	5	4.90	41	13.3	4	10	5.2
	7/16"; 1/2"x20	3/4"-1"x20	20	HCF10096L22-I20UNTM4...	10	9.60	72	22.2	4	17	9.8
5/16"x18	9/16"; 5/8"x18	11/16"-1 1/16"x18	18	HCF06059L16-I18UNTM4...	6	5.90	59	16.2	4	11	6.5
3/8"x16	3/4"x16		16	HCF08076L19-I16UNTM4...	8	7.60	64	19.8	4	12	8.0
7/16"x14	7/8"x14		14	HCF08078L22-I14UNTM4...	8	7.80	67	22.7	4	12	9.3
1/2"x13			13	HCF10099L26-I13UNTM5...	10	9.90	75	26.4	5	13	10.8
9/16"x12	1"-1 1/2"x12		12	HCF12118L28-I12UNTM5...	12	11.80	83	28.6	5	13	12.3
5/8"x11			11	HCF14131L33-I11UNTM5...	14	13.10	90	33.5	5	14	13.5
3/4"x10			10	HCF16159L39-I10UNTM5...	16	15.90	98	39.4	5	15	16.5
1x8"			8	HCF20199L52-I8UNTM5...	20	19.90	107	52.4	5	16	22.0

## BSP

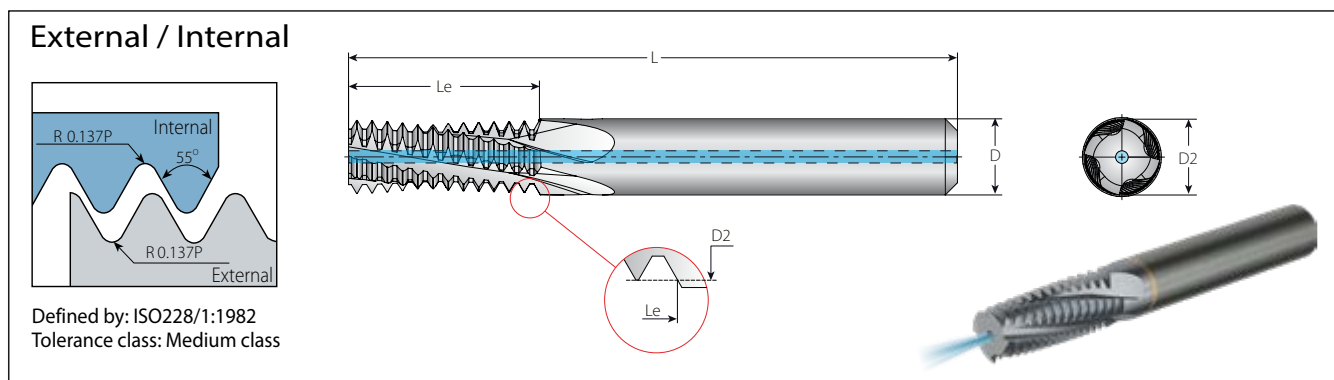

### Helical Flutes with Thru-Hole Coolant

2 x Do ( $Le \leq 2 \times \text{Thread Diameter}$ )

Thread	Pitch	Ordering Code	Dimensions mm			No. of Flutes	Teeth	Bore Dia.	
Standard	TPI	External / Internal	D	D2	L	Le	Z	Zt	mm
1/8"x28	28	HCF08079L19-EI28BSPTM4...	8	7.90	62	19.5	4	21	8.7
1/4"x19, 3/8"x19	19	HCF10099L27-EI19BSPTM5...	10	9.90	75	27.4	5	20	11.8, 15.2
1/2"x14, 3/4"x14	14	HCF16159L42-EI14BSPTM5...	16	15.90	99	42.6	5	23	19.0, 24.4

\*\* Bore diameter applies to smallest thread dia.

# NPT

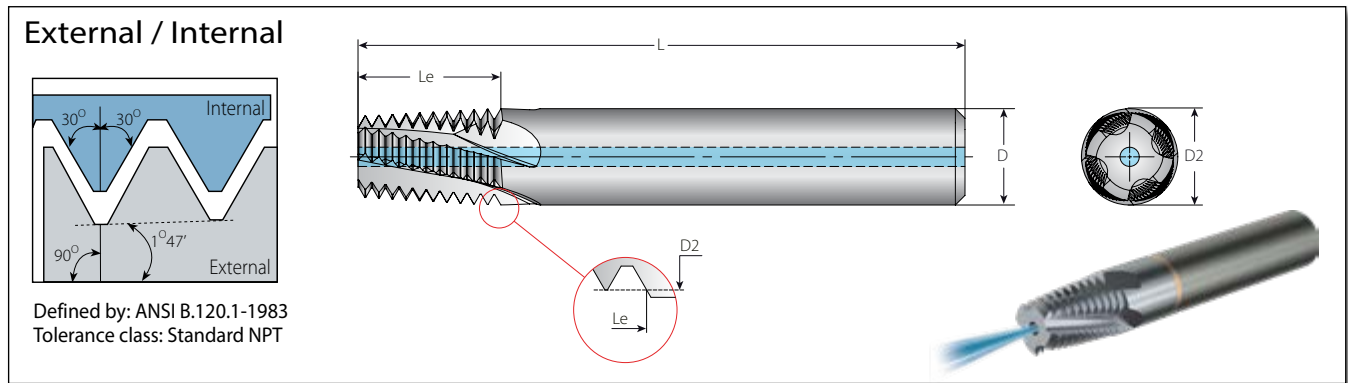

## Helical Flutes with Thru-Hole Coolant

Thread	Pitch	Ordering Code	Dimensions mm				No. of Flutes	Teeth	Bore Dia.
			D	D2	L	Le			
Standard	TPI	External / Internal	D	D2	L	Le	Z	Zt	mm
1/16"x27	27	HCF06059L09-EI27NPT-TM4...	6	5.90	53	9.9	4	10	6.3
1/8"x27	27	HCF08076L09-EI27NPT-TM4...	8	7.65	53	9.9	4	10	8.5
1/4"x18, 3/8"x18	18	HCF10099L14-EI18NPT-TM4...	10	9.90	63	14.8	4	10	11.1, 14.5
1/2"; 3/4"x14	14	HCF14139L19-EI14NPT-TM5...	14	13.90	75	19.0	5	10	17.7, 23.0
1", 1 1/4", 1 1/2", 2", x11.5	11.5	HCF18179L23-EI11.5NPT-TM5...	18	17.90	80	23.2	5	10	29.0, 37.7, 44.0, 56.0



## Recommended Cutting Speeds Vc [m/min] and Feed f [mm/tooth] for MACH TM

Material Group	Vargus No.	Material	Hardness Brinell HB	Vc [m/min]	Feed f [mm/tooth]			
				VH4	D2≤4 mm	D2≤8 mm	D2>8 mm	
<b>P</b> Steel	1	Unalloyed Steel	Low Carbon (C=0.1-0.25%)	125	80-250	0.04-0.08	0.09-0.13	0.06-0.20
	2		Medium Carbon (C=0.25-0.55%)	150	80-230	0.04-0.08	0.09-0.13	0.06-0.20
	3		High Carbon (C=0.55-0.85%)	170	80-200	0.04-0.08	0.09-0.13	0.06-0.20
	4	Low Alloy Steel (alloying elements≤5%)	Non Hardened	180	60-180	0.04-0.08	0.09-0.13	0.06-0.20
	5		Hardened	275	60-170	0.04-0.08	0.09-0.13	0.06-0.20
	6	High Alloy Steel (alloying elements>5%)	Annealed	350	60-160	0.03-0.06	0.05-0.10	0.06-0.12
	7		Hardened	200	40-100	0.04-0.08	0.09-0.13	0.06-0.20
	8	Cast Steel	Low Alloy (alloying elements <5%)	325	30-80	0.03-0.06	0.05-0.10	0.06-0.12
	9		High Alloy (alloying elements >5%)	200	80-250	0.04-0.08	0.09-0.13	0.06-0.20
	<b>M</b> Stainless Steel	10	Stainless Steel Ferritic	Non Hardened	225	60-170	0.04-0.08	0.09-0.13
11		Hardened		200	60-150	0.03-0.06	0.05-0.10	0.06-0.12
12		Stainless Steel Austenitic	Austenitic	330	60-120	0.015-0.03	0.03-0.05	0.02-0.06
13			Super Austenitic	180	60-140	0.04-0.08	0.09-0.13	0.06-0.20
14		Stainless Steel Cast Ferritic	Non Hardened	200	60-130	0.03-0.06	0.05-0.10	0.06-0.12
15			Hardened	200	60-160	0.03-0.06	0.05-0.10	0.06-0.12
16		Stainless Steel Cast Austenitic	Austenitic	330	60-110	0.03-0.06	0.05-0.10	0.06-0.12
17			Hardened	200	60-150	0.03-0.05	0.05-0.10	0.05-0.11
18	Grey Cast Iron	Ferritic (short chips)	330	60-100	0.015-0.03	0.03-0.05	0.02-0.06	
19		Pearlitic (long chips)	230	60-150	0.04-0.08	0.09-0.13	0.06-0.20	
<b>K</b> Cast Iron	20	Malleable Cast Iron	Low Tensile Strength	180	70-160	0.04-0.08	0.09-0.13	0.06-0.20
	21		High Tensile Strength	260	40-120	0.03-0.06	0.05-0.10	0.06-0.12
	22	Nodular Sg Iron	Ferritic	160	40-110	0.04-0.08	0.09-0.13	0.06-0.20
	23		Pearlitic	260	40-100	0.03-0.06	0.05-0.10	0.06-0.12
<b>N</b> Non-Ferrous Metals	24	Aluminum Alloys Wrought	Non Aging	60	200-300	0.06-0.11	0.10-0.17	0.09-0.20
	25		Aged	100	150-250	0.03-0.09	0.05-0.12	0.05-0.14
	26	Aluminum Alloys	Cast	75	100-200	0.06-0.11	0.10-0.17	0.09-0.20
	27		Cast & Aged	90	120-220	0.03-0.09	0.05-0.12	0.05-0.14
	28	Aluminum Alloys	Cast Si 13-22%	130	200-300	0.06-0.11	0.10-0.17	0.09-0.20
	29	Copper and Copper Alloys	Brass	90	200-300	0.06-0.11	0.10-0.17	0.09-0.20
	30		Bronze And Non Leaded Copper	100	150-250	0.03-0.09	0.05-0.12	0.05-0.14
	<b>S</b> Heat Resistant Material	31	High Temperature Alloys	Annealed (iron based)	200	30-60	0.03-0.06	0.05-0.10
32		Aged (iron based)		280	20-50	0.015-0.03	0.03-0.05	0.02-0.06
33		Annealed (nickel or cobalt based)		250	15-35	0.015-0.03	0.03-0.05	0.02-0.06
34		Aged (nickel or cobalt based)		350	15-30	0.015-0.03	0.03-0.05	0.02-0.06
35		Titanium Alloys	Pure 99.5 Ti	400Rm	40-80	0.015-0.03	0.03-0.05	0.02-0.06
36			α+β Alloys	1050Rm	20-50	0.015-0.03	0.03-0.05	0.02-0.06

Pitch		No. of Passes
mm	TPI	
≤1.75	≥14	1
≥1.75-2.0	≤14-12	2
≥2.0	≤12	Multi-passes



Grade	Application	Sample
<b>VH4</b>	High wear resistance for general purpose applications. TiCN PVD Coating	

When using the higher feed of the range [mm/tooth], we recommend increasing the depth of the pre-drilled hole by 2-3 pitches.

With a network of 14 international companies and hundreds of distributors, warehouses and certified ISO 9001 manufacturing facilities, VARGUS Ltd. serves customers in more than 100 countries around the globe. A customer-focused organization, VARGUS Ltd. is committed to providing innovative products and solutions of the highest quality and excellent value, and is renowned for its technical expertise and uncompromising service.

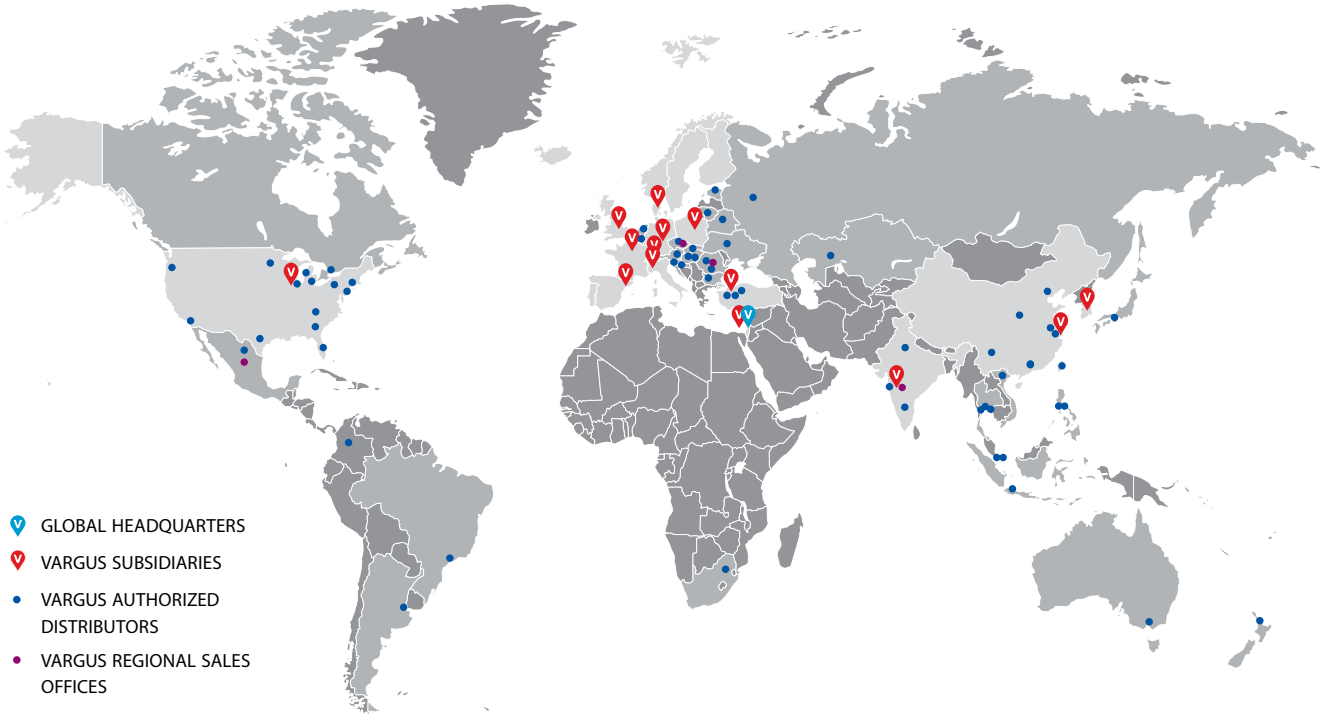

**VARGUS Ltd. - Global Headquarters | ISRAEL** +972 4 9855 101 | [mrktg@vargus.com](mailto:mrktg@vargus.com)

## EUROPE

 **VARGUS Scandinavia**  
[vargus@vargus.dk](mailto:vargus@vargus.dk)

 **VARGUS France**  
[commercial@vargus.fr](mailto:commercial@vargus.fr)

 **VARGUS Germany**  
[info@vargus.de](mailto:info@vargus.de)

 **NEUMO-VARGUS**  
[neumo@neumo-vargus.co.il](mailto:neumo@neumo-vargus.co.il)

 **VARGUS Novatea**  
[info@novatea.it](mailto:info@novatea.it)

 **VARGUS Poland**  
[vargus@neumo.pl](mailto:vargus@neumo.pl)

 **VARGUS Ibérica**  
[sales@vargus.es](mailto:sales@vargus.es)

 **VARGUS Switzerland**  
[info@vargus.ch](mailto:info@vargus.ch)

 **VARGUS Turkey**  
[ugurc@vargus.com](mailto:ugurc@vargus.com)

 **VARGUS Tooling UK**  
[tooling.uk@vargustooling.co.uk](mailto:tooling.uk@vargustooling.co.uk)

 **Romania Sales Office**  
[sales-ro@vargus.com](mailto:sales-ro@vargus.com)

 **Czech Republic & Slovakia Sales Office**  
[sales-czsk@vargus.com](mailto:sales-czsk@vargus.com)

## ASIA

 **VARGUS China**  
[info@varguschina.net](mailto:info@varguschina.net)

 **VARGUS India**  
[info@vargusindia.com](mailto:info@vargusindia.com)

 **VARGUS Korea**  
[info@varguskorea.co.kr](mailto:info@varguskorea.co.kr)

**Asia Pacific Sales Office**  
[prasadp@vargus.com](mailto:prasadp@vargus.com)

## NORTH AMERICA

 **VARGUS USA**  
[sales@vargususa.com](mailto:sales@vargususa.com)

 **Mexico Sales Office**  
[sales-mx@vargus.com](mailto:sales-mx@vargus.com)